



Santa Maria
General Plan

imagine



Alternatives Technical Memorandum

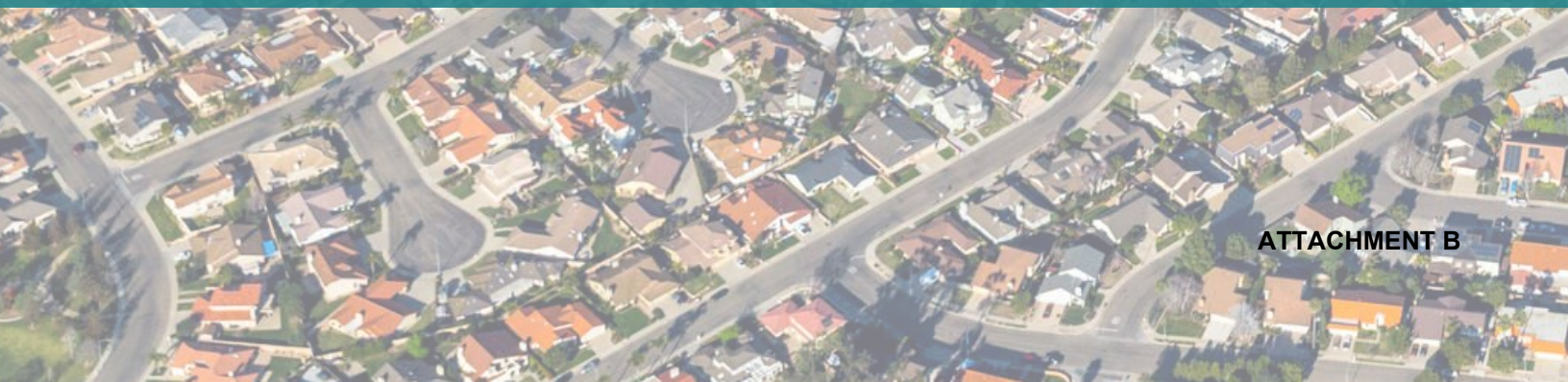

ATTACHMENT B

Table of Contents

Introduction 1

Role of Alternatives in the Planning Process 1

Key Factors Driving Alternatives 12

Introduction to Land Use Alternatives 18

Alternative A: Annexation 27

Alternative B: City Infill 31

Alternative C: Hybrid 35

Growth Projections 39

Mobility Alternatives 40

Public Realm Alternatives 47

Appendix A: Mobility Alternatives Memorandum 51

Appendix B: Public Realm Design Options 52

Figures

Figure 1: Areas of Stability and Change 4

Figure 2: General Plan Land Use 7

Figure 3: Existing Land Use 9

Figure 4: Alternative A Land Use Mix 29

Figure 5: Alternative A Land Use 30

Figure 6: Alternative B Land Use Mix 33

Figure 7: Alternative B Land Use 34

Figure 8: Alternative C Land Use Mix 37

Figure 9: Alternative C Land Use 38

Figure 10: Cross Section of a Road Diet Concept 42

Figure 11: Existing Typical Section for Secondary Arterial (Residential Street) 44

Figure 12: Existing Typical Section for Secondary Arterial (Commercial Street) 44

Figure 13: Proposed Typical Section for Secondary Arterial (Parking-Protected Bike Lanes) 44

Figure 14: Proposed Typical Section for Secondary Arterial (Buffered Bike Lanes and Parking) 44

Figure 15: Existing Typical Section for Primary Arterial (Residential Street) 45

Figure 16: Existing Typical Section for Primary Arterial (Commercial Street) 45

Figure 17: Proposed Typical Section for Primary Arterial (Bicycle Lane with Raised Buffer) 45

Figure 18: Proposed Typical Section for Primary Arterial (Transit Only Lane) 46

Figure 19: Primary Arterial 48

Figure 20: Secondary Arterial.....48
Figure 21: Toolkit.....49

Tables

Table 1: General Plan Land Use 8
Table 2: Existing Land Use 10
Table 3: SBCAG Growth Projections 15
Table 4: SBCAG Projected Jobs 16
Table 5: Minimum Residential Growth to Plan for 18
Table 6: Commonalities Across Alternatives 18
Table 7: Land Use Designations 21
Table 8: Alternative A Land Use Mix 28
Table 9: Alternative B Land Use Mix 32
Table 10: Alternative C Land Use Mix 36
Table 11: Projected New Dwelling Unit and Job Growth 39
Table 12: Projected Total Population, Dwelling Units, and Jobs 40
Table 13: Mobility Alternatives Comparison 47

Alternatives Technical Memorandum

Introduction

This Technical Memorandum is the deliverable for Task 4.4 of the General Plan Update scope of work and describes land use, mobility, and public realm Alternatives to address key issues identified so far in the Santa Maria General Plan Update process. The three land use Alternatives build off the areas of change identified as part of work undertaken per scope of work Task 4.2 as well as the working meeting held for Task 4.3 and Technical Advisory Committee input. The information summarized in this report will later be used to for community engagement that informs the selection of a preferred alternative (Task 4.8).

This Technical Memorandum first provides background information about Alternatives, including the role of Alternatives in the General Plan Update process, factors impacting Alternatives development, and growth the Alternatives must plan for. From there, the Technical Memorandum discusses the three land use Alternatives, including commonalities and differences between the Alternatives, land use designations, growth projections and the vision and direction of each Alternative. Mobility and public realm Alternatives are described in detail in Appendices A and B, respectively, but short synopses of these Alternatives are included in the body of the Technical Memorandum.

This Technical Memorandum will be followed by technical analysis on the Alternatives. This technical analysis, scoped as Tasks 4.5 and 4.7, will include an analysis of the fiscal impacts of the three land use Alternatives and an evaluation of the land supply and market demand of the three Alternatives, which is part of Task 4.4. The results of Task 4.6, the traffic analysis of land use Alternatives, is incorporated into Appendix A, the Mobility Alternatives Memorandum.

Role of Alternatives in the Planning Process

Background and Process

What is the Santa Maria General Plan Update?

The City of Santa Maria is undertaking a multi-year effort to update its General Plan to establish strong and visionary policies that support economic development, sustainability, and improved quality of life in the city.

A General Plan is a policy document required by State law that provides long-range guidance for land use, development and other issues such as economic growth, open space, conservation, affordable housing, and employment. The General Plan also offers an opportunity for the community to engage in the planning process and to help define the long-term needs of residents, businesses, and employees.

The Santa Maria General Plan Update will cover topics that are important to the community including those mandated by State law. These include: Land Use and Community Design, Circulation and Mobility,

Safety, Health and Environmental Justice, Conservation/Open Space, Noise, Public Facilities and Services, and Economic Development.

General Plan Update Process

The General Plan Update has five major phases, which are designed as step-by-step building blocks (see the image below). The project is currently in the “Plan Alternatives” phase.

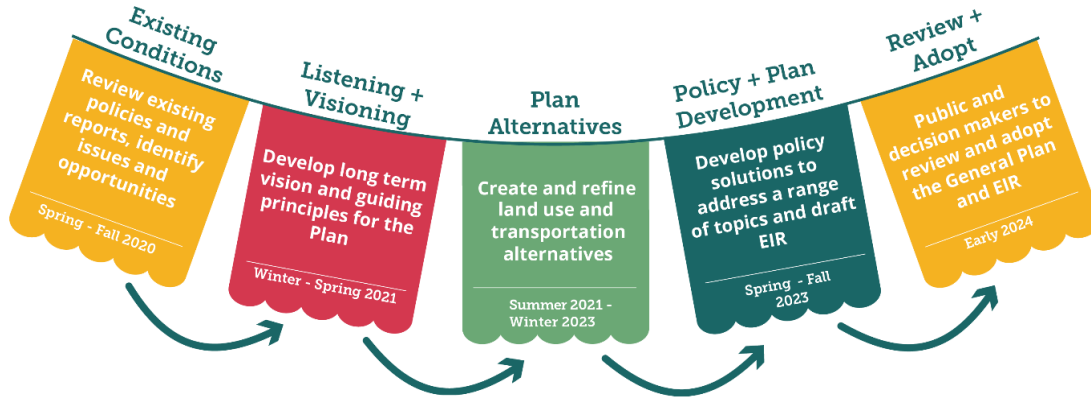

In 2020, during the Existing Conditions phase and to initiate the Listening + Visioning phase, City staff worked closely with the consultant team to systematically collect identify trends, issues, opportunities, and priorities, which are summarized in seven existing conditions reports (ECRs) that are available on the project website, www.ImagineSantaMaria.com.

Throughout the Listening + Visioning Stage, community members shared their vision for the future, qualities of Santa Maria to preserve, and issues to address. This engagement was conducted via nine Technical Advisory Committee meetings, three online surveys, one virtual community workshop, 17 stakeholder interviews, four community cafes conducted in partnership with Central Coast Alliance United for a Sustainable Economy (CAUSE), and meetings with City staff across departments. The City spread awareness of the General Plan Update in English and Spanish via a number of channels, including newsletter emails, utility bill mailers, communications with local non-profit organizations, social media posts, press releases, and updates to the project website, www.ImagineSantaMaria.com. Full results from community engagement, presented in engagement summary reports, can be found on the resources page of the project website, ImagineSantaMaria.com.

Vision, Guiding Principles, and Areas of Change and Stability

Using a systematic process of reviewing all the key findings from the Existing Conditions Reports and community input from the Listening + Visioning Stage, the planning team produced the [Vision, Guiding Principles, and Areas of Change and Stability](#) document, which was approved by City Council in April 2021. Specifically, for each General Plan topic (e.g., land use, mobility, hazards, environmental justice, etc.) and for each area of the city, qualities to preserve, opportunities to capitalize on, challenges to address, and changes to advance were organized. From there, key themes were summarized to prepare a concise Vision Statement, to develop topic-specific Guiding Principles, and to identify Areas of Change and Stability by neighborhood and corridor. The Vision, Guiding Principles, and Areas of Change and Stability discuss topics central to Santa Maria, including agricultural identity; culture, history, and art;

community design; community health; natural environment and resilience; housing quality and choice; resilient economy; connected growth; transportation innovations; infrastructure, utilities, facilities, and services; and governance and engagement.

The Plan Alternatives stage builds off of the Vision, Guiding Principles, and Areas of Change and Stability document. The Areas of Change and Stability map identifies Areas of Stability, where limited physical changes are anticipated but improvements continue to be made, as well as areas of potential transformation, where transformational change is planned or should be considered. The Alternatives phase of the planning process focuses primarily on Areas of Potential Transformation. For Areas of Stability and Enhancement, the updated General Plan will incorporate strategies to preserve and enhance existing assets and address needed improvements. The Areas of Stability and Enhancement and Areas of Potential Transformation are shown in Figure 1.

Land Use Alternatives

Alternatives identify different land use, mobility, and urban design options the City has to achieve the community's Vision and implement the Guiding Principles. Land use Alternatives are the foundation.

Land Use Designations

The land use Alternatives are distinguished by where they propose changes in General Plan land use designations in different Areas of Change across the city. General Plan land use designations identify the intended future use of every parcel of land in the city. According to State law, land use designations must identify the allowed uses and the development intensity (measured in dwelling units per acre, floor area ratio (FAR) or jobs/residents per acre). Zoning districts must be consistent with the General Plan land use designations.

While land use designations provide for overall development intensity and allowed uses, they do not specify the form or character of the building. Different interpretations of the same density and FAR can result in buildings of very different character. To encourage similar interpretations of allowed FARs, other City regulations such as zoning height limits, building setbacks, or open space requirements are used to guide the form of buildings within a given FAR range.

It is important to note a few limitations of land use designations. Land use designations cannot require specific uses or tenants. This means that the General Plan cannot require the type of ownership of buildings (rental versus ownership, or specific tenants in buildings). For example, the General Plan cannot require or prohibit that specific parcels be used for affordable housing, senior housing, special-needs housing, or prohibit certain types of tenants in commercial spaces (such as chain stores). Further, land use designations do not identify specific locations for parks, schools, and public buildings.

Existing General Plan

The City's existing General Plan Land Use Element (LUE) was adopted in 1970 and amended in 2011. The LUE designates the proposed general distribution, general location, and extent of the uses of the land. The Land Use Classifications (designations) in the LUE provide for the distribution of varying uses as indicated on the Land Use Policy Map and specify the maximum density allowed per gross acre of land. Existing General Plan land use designations are mapped in Figure 2, and their acreages are shown in Table 1. The General Plan defers to the Zoning Ordinance to establish specific development standards, including minimum lot sizes. The existing LUE map and designations will be updated as part of this General Plan Update, though most parcels in the city are not likely to have significant changes to their designations, particularly those identified as Areas of Stability.

The existing General Plan land use map and designations are informed by existing LUE goals, which are as follows:

- Goal L.U.1 - Community Character. Maintain and improve the existing character of the community as the industrial and commercial retail center for northern Santa Barbara County and southern San Luis Obispo County.
- Goal L.U.2 - Urban Services. Provide all necessary urban services and facilities for present and future city residents, which include providing sufficient land for community facilities (i.e., fire station, police station, library, cultural center, and public transit).

- Goal L.U.3 - Urban Design. The City will promote quality urban design enhancing Santa Maria's character.
- Goal L.U.4 - Industrial and Commercial Uses. New employment generating clean and low water demand industry and commercial uses will be encouraged to locate in Santa Maria, and activities of this type presently located in the city will be encouraged to remain.
- Goal L.U.5 - Development Continuity. Discourage sprawl and "leapfrog" development.
- Goal L.U.6a - Balance Growth. Accommodate new development, balancing social, environmental and economic considerations.
- Goal L.U.6b - Preserve Agricultural Resources. Accommodate growth while making every effort to preserve agricultural resources in the surrounding region.
- Goal L.U.6c - Urban/Agriculture Equilibrium. Achieve a balance between increased developments and the maintenance, management, and/or preservation of local resources.
- Goal L.U.7 - Land Use Conflict Reduction. Reduce existing and potential land use conflicts.
- Goal L.U.8 - Planning Coordination. Coordinate planning efforts both within the city and with other jurisdictions in the region.
- Goal L.U.9 - Promote Adequate Housing Supply. The City will continue to promote an adequate supply of quality residential development within Santa Maria.
- Goal L.U.10 - Promote High Quality Commercial and Industrial Development. Continue to promote quality commercial and industrial development in Santa Maria and encourage the upgrading and revitalization of the existing commercial and industrial areas.
- Goal L.U.11 - Balance Land Use Supplies. The City will address the present imbalance between the land area designated for residential development and for those areas designated industrial and commercial development.
- Goal L.U.12 - Water Supply. Participate in and implement programs and measures which effectively conserve water.

Existing Land Use

Existing land use refers to the way land is developed and currently being used in Santa Maria. Existing land use may differ from General Plan land use, which identifies intended future use of each parcel. Existing land use is important to understand when developing land use Alternatives, particularly when considering existing uses of parcels surrounding areas where change is expected. Figure 3 and Table 2 show existing land use in Santa Maria.

Figure 2: General Plan Land Use

General Plan Land Use

Legend

- City Limits
- Sphere of Influence
- Parks
- Water
- Railroads
- Freeways/Highways
- Major Streets
- Local Streets

General Plan Land Use

Conservation and Agriculture

- Primary Agricultural Open Space (AOS-I)
- Secondary Agricultural Open Space (AOS-II)
- Conservation Open Space (COS)
- Recreational Open Space (ROS)

Public

- Community Facilities (CF)

Residential

- High Density Residential (HDR-22)
- Medium Density Residential (MDR-12)
- Medium Density Residential (MDR-10)
- Low Medium Density Residential (LMDR-8)
- Low Density Residential (LDR-5)
- Lower-Density Residential (LWDR-4)
- Residential Agricultural District (RA)

Commercial

- Community Commercial (CC)
- Central District I (CD-I)
- Central District II (CD-II)
- Commercial/Professional Office (CPO)
- Freeway Service (FS)
- Neighborhood Commercial (NC)

Industrial

- General Industrial (GI)
- Heavy Commercial/Manufacturing (HCM)
- Light Industrial (LI)
- Airport - Airport Service (A-AS)

Specific Plan

- Specific Plan (SP)

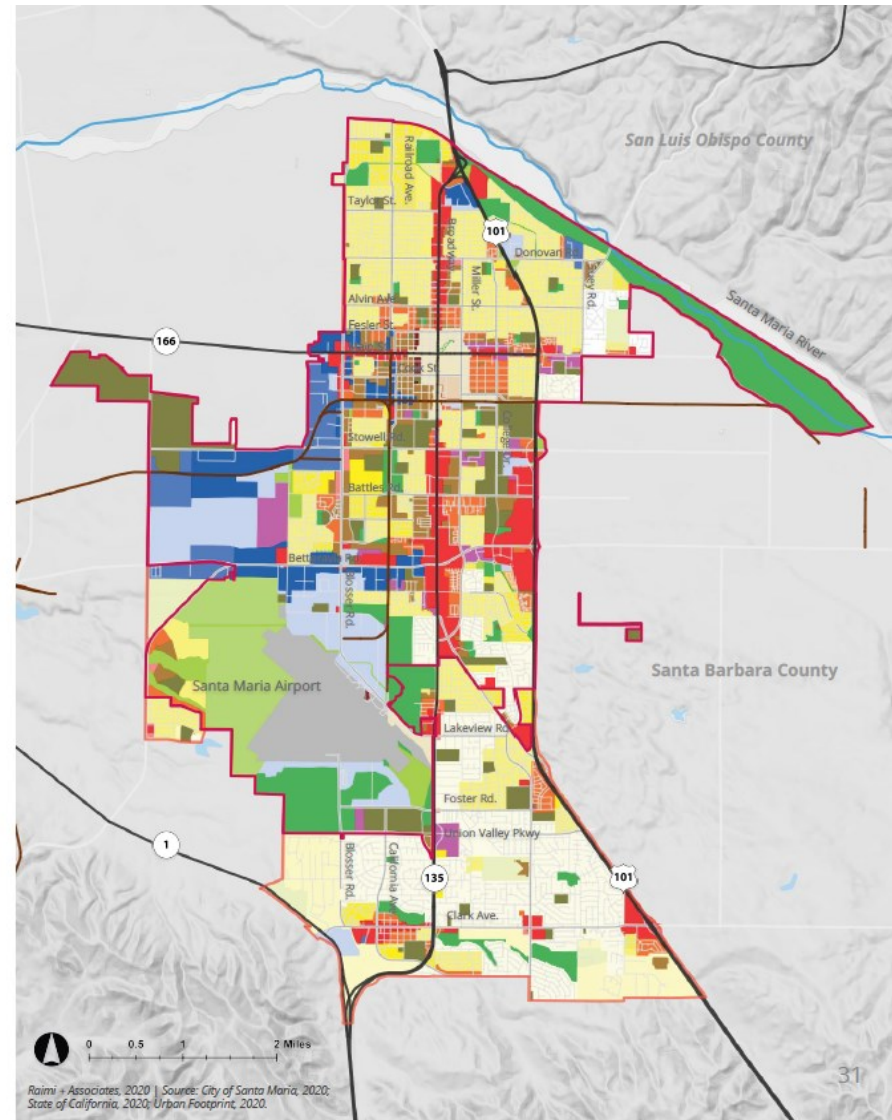

Table 1: General Plan Land Use

General Plan Land Use Classifications

General Plan Land Use Classifications

Land Use Classification	Acres	% of City	Corresponding Zoning	Max. Res. Density (units/acre)
Residential		31.74%		
RA	0	0%	R-A, Planned Development (PD) overlay	2
LWDR-4	476	3.75%	R-A-5, R-1-40,000 to R-1-10,000, PD overlay	4
LDR-5	2,013	15.87%	R-1, R-1-6,000 to R-1-10,000, RMH, PD overlay	5
LMDR-8	500	3.94%	RSL-1, RMH, R-1, R-2, PD overlay	8
MDR-10	7	0.06%	R-2, PD overlay	10
MDR-12	469	3.70%	R-2, PD overlay	12
HDR-22	561	4.42%	R-3, PD overlay	22
Commercial		9.32%		
NC	30	0.24%	C-1, CC, CPO, PD overlay	12 ADUs
CC	801	6.31%	C-1, C-2, PD overlay	
CPO	272	2.14%	CPO, PD overlay	30 ¹
CD-I	31	0.24%	C-1, PD overlay, Specific Plan (SP)	
CD-II	14	0.11%	R-3, PF, C-1, PD overlay, SP	40
FS	35	0.28%	FS, HC, PD overlay	
Industrial		25.37%		
LI	1,151	9.07%	M-1, PD overlay	
HCM	677	5.34%	CM, PD overlay	
GI	424	3.34%	M-2, PD overlay	
A-AS	966	7.61%	AA, CZ, AS-I, AS-II, AS-III, PD overlay	

1. Senior citizen housing may also be permitted to a maximum density of 30 dwelling units per acre with special review by the Planning Commission.

Land Use Classification	Acres	% of City	Corresponding Zoning	Max. Res. Density (units/acre)
Public		8.73%		
CF	1,108	8.73%	PF, PD overlay	
Open Space		23.02%		
AOS-I	65	0.51%	OS, PD overlay	
AOS-II	899	7.09%	OS, PD overlay	
COS	269	2.12%	OS, PD overlay	
ROS	1,688	13.30%	OS, PD overlay	

Major Categories

- Conservation and Agriculture
- Residential
- Commercial
- Public and Institutional
- Industrial
- Airport
- Specific Plan

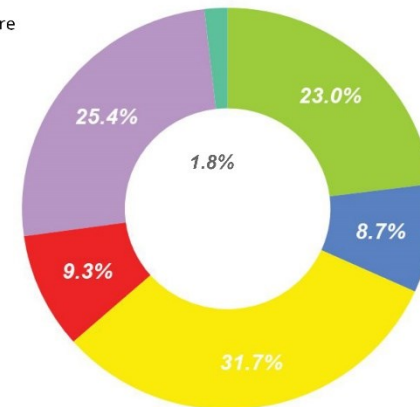

Figure 3: Existing Land Use

Existing Land Use

Legend

- City Limits
- Sphere of Influence
- Parks
- Water
- Railroads
- Freeways/Highways
- Major Streets
- Local Streets

Existing Land Use Types

Conservation and Agricultural

- Agriculture
- Water

Public

- Church
- Elementary School
- High School
- College/Universities
- Government Office
- Hospital
- Parks and Recreation
- Right of Way
- Vacant

Residential

- Apartments
- Condominiums
- Mobile Home
- Single-family Dwellings

Commercial

- Auto Service and Sales
- Service Station
- Medical Office
- Office
- Indoor Recreation
- Neighborhood Commerce
- Hotel/Motel
- Theater
- Restaurants
- Bank
- Regional Commerce

Industrial

- Light Industry
- Heavy Industry
- Warehouse
- Airport

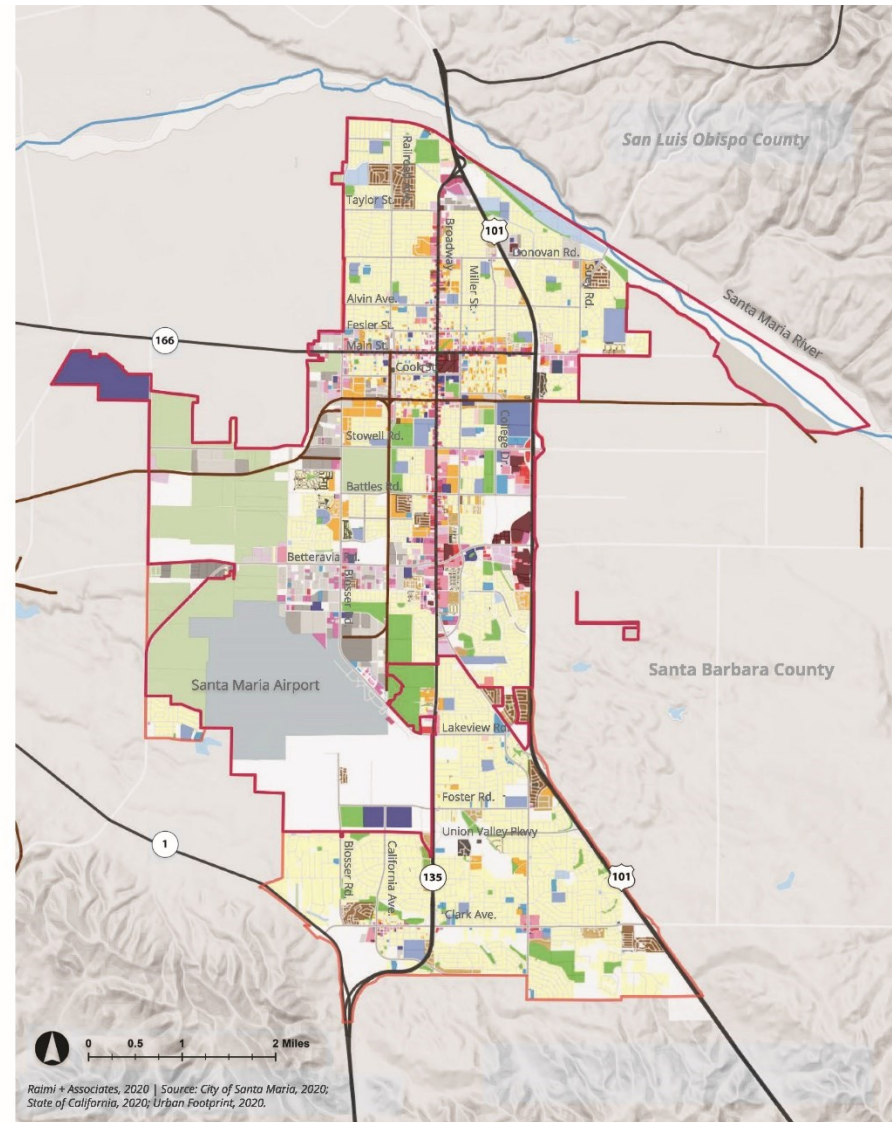

*The existing land use data in the SOI is not verified by the City.

Table 2: Existing Land Use

Existing Land Use

Existing Land Use

Land Use	Acres	% of City
Residential	3,486	27.3
Single-Family Residential	2,806	22.0
Condominiums	113	0.9
Apartment	359	2.8
Mobile Home	208	1.6
Commercial	948	7.4
Auto Service and Sales/service station	218	1.7
Bank	16	0.1
Hotel/Motel	41	0.3
Indoor Recreation	46	0.4
Neighborhood Commerce	249	2.0
Office	161	1.3
Regional Commerce	131	1.0
Restaurants	66	0.5
Theater	20	0.2
Industrial	1,082	8.5
Light Industry	759	6.0
Heavy Industry	61	0.5
Warehouse	262	2.1
Airport	1,411	11.1
Public and Institutional	1,408	11.0
Church	85	0.7
Colleges/Universities	84	0.7

Land Use	Acres	% of City
Government Office	362	2.8
Hospital	11	0.1
Medical Office	67	0.5
Parks and Recreation	521	4.1
Schools (K-12))	278	2.2
Conservation and Agriculture	1,828	14.3
Agricultural	1,649	12.9
Water	179	1.4
Other	2,589	20.3
Private Right-of-Way	106	0.8
Vacant	2,483	19.5
Total	12,752	100.0

Major Categories

- Conservation and Agriculture
- Residential
- Commercial
- Public and Institutional
- Industrial
- Airport

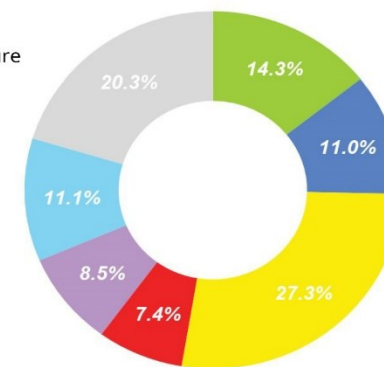

Alternatives Analysis and Comparison

The Alternatives will be reviewed and evaluated by City staff, decision-makers, and the community. The purpose of the Alternatives evaluation is for the community and the City to assess trade-offs among the Alternatives and identify which Alternative (or combination of Alternatives) best fulfills the community's Vision.

Objective metrics will be used to compare Alternative options for specific physical development and improvement, including the following:

Land use:

- Land use mix
- Acreage of greenfield development
- Range of housing options and which types

Transportation:

- Vehicle miles travelled per capita, household, and employees
- Level of service
- Vehicle to capacity ratio

Environment:

- Greenhouse gas impacts
- Energy use
- Development on agricultural land
- Cultural resources
- Hazards
- Critical habitat
- Noise
- Impact on public services

Fiscal Impact:

- City revenues
- City expenses

Health and Environmental Justice:

- Access to parks and open space
- Access to healthy food
- Access to transit
- Access to retail
- Air quality

Public Engagement and City Council Selection of the Preferred Alternative

The Alternatives and the results of the technical analysis will be presented to the community for review and evaluation. Following this step, the Alternatives and the results of engagement will be shared with the Planning Commission and City Council along with recommendations for a Preferred Alternative,

which may be one of the three land use Alternatives or a combination of various components from two or more of the Alternatives. The City Council will approve the Preferred Alternative.

Relation to the Annexation Study

The Preferred Alternative will be evaluated relative to its impacts on infrastructure. If the Preferred Alternative includes annexation, the project team will conduct an Annexation Study to identify infrastructure and capital improvements needed to accommodate future growth in annexation areas. This task will include a fiscal assessment, which will evaluate projected City revenues and expenses associated with land uses in annexation areas, as well as an evaluation of environmental features and constraints in the annexation area. This task will also include conversations with the Santa Barbara County Local Agency Formation Commission (LAFCO) to discuss annexation and determine the process of incorporation of the annexation area into City limits.

Key Factors Driving Alternatives

Opportunities and Constraints

The following list of key factors was derived based on findings from existing conditions analysis, conversations with City staff, and review from the Technical Advisory Committee. This is not an exhaustive list of opportunities and constraints in the city, but instead a list of leading factors that shaped land use, mobility, and public realm Alternatives.

Opportunities

Downtown Santa Maria. Downtown is the most walkable part of the city, it has a diverse mix of land uses and housing types, and it has many of Santa Maria’s historic, civic, and cultural resources.

Implementation of the Downtown Specific Plan and the Downtown Multimodal Streetscape Plan could create opportunities for job and population growth and transformational improvements to the roadways and public realm.

ADUs and JADUs. ADU and JADUs are currently allowed in Santa Maria per State law and may be able to accommodate projected housing growth in Santa Maria over the General Plan horizon.

Corridor Revitalization. Either the General Plan or an updated Entrada Specific Plan could include circulation, mobility, streetscape, built form, design components, and incentives for higher densities, intensification, and mixed-use redevelopment along the Main and Broadway Corridors, as recommended by the regional Sustainable Communities Strategies (RTP/SCS). The City has limited authority over the Main Street and Broadway rights-of-way because these corridors are owned by the State, but the General Plan Update may be an opportunity to determine if the City should seek to assume responsibility over these corridors from the State.

Vacant land. There is vacant and developable land that can accommodate new housing and/or employment growth over the General Plan horizon.

Opportunity sites. Many developed areas have low improvement ratios and/or a low FAR, indicating redevelopment opportunities.

Character and Design. Commercial and industrial places and streets generally have the greatest potential for improved mobility, enhanced character, and placemaking due to low-slung development and large areas devoted to surface parking. Residential places and streets are generally more stable, although opportunities do exist for public realm, streetscape, and connectivity improvements.

Improving Access to Amenities, Schools, and Services. Residents in most areas of the city do not have convenient walking access to schools, parks, food, and/or retail. The GPU may be an opportunity to introduce more walking and biking infrastructure to better connect people with amenities, and introduce commercial land uses near primarily residential areas to provide more access to amenities

Annexation. Annexation of land outside of City boundaries may be an opportunity for growth.

Constraints

Land Use Conflicts. Industrial uses are occasionally located next to residential uses, creating abrupt transitions. Residents living next to industrial facilities may be exposed to emissions, odors, noise, and other factors detrimental to public health. Land use conflicts should be avoided when designing Alternatives.

Disconnected Development. Some recent subdivision developments have created urbanized, primarily residential areas disconnected from the rest of the city and many of its amenities. Residents often have no choice but to drive to reach their destinations. Outward expansion of the city may create other residential areas disconnected from the rest of the city.

Infrastructure. The City of Santa Maria's wastewater treatment plant, water system, and stormwater system require improvements. Historically some of these costs have been passed on to developers, which makes development more expensive. Per the Downtown Specific Plan EIR, buildout of the Downtown Santa Maria Specific Plan would result in 424,300 gallons per day in wastewater, which would exceed the capacity of existing sewer pipes. Growth of the city through 2045, both within and outside City limits, will continue to strain the city's infrastructure.

Hazardous Sites. The siting of hazardous, clean up, and solid waste facilities near residential neighborhoods, particularly low-income communities, poses a serious threat in case of a hazard release emergency. In Santa Maria, there are five hazardous waste generators and one treatment, storage, and disposal facility (TSDF) that impact disadvantaged communities, given the concentration of these facilities to homes and the large generation of waste they produce.

Groundwater Threats. A concentration of oil and gas wells exists in the city, particularly south of Stowell Road. Oil companies are leading various remediation efforts of old sites. However, the City will need to consider how to address the impacts of idle and plugged oil well sites, including cleanup and the threat of potential leaks.

Changing nature of retail. The growth of e-commerce has reduced consumer demand for brick and mortar retail.

Post-pandemic impacts. The long-term effects of the COVID-19 pandemic are not clear. In the short term, it has caused trends, including remote work, changing housing and living preferences, growth of

food delivery services and some online retail services, that should be considered when planning for Santa Maria long-term.

Airport Land Use Compatibility. The Santa Maria Public Airport is located in the southwestern corner of Santa Maria. Land uses adjacent to the Airport may be exposed to hazards related to landing and approach zones, airplane accidents, and noise.

Biological Resources. The city is home to plant and animal species, particularly along the Santa Maria River, near the Santa Maria Public Airport, Area 9 Specific Plan area, and areas that pond in agricultural areas, that are protected due to their status as a State or federal species of concern. Per the Airport Business Park Specific Plan, the Department of Fish and Wildlife has issued a biological opinion which outlines mitigation measures to reduce impacts to Federal and State listed sensitive species and endangered species including vernal pool fairy shrimp, California Tiger Salamander, and the California Redlegged Frog found on site.

Major Noise Sources. The Santa Maria Public Airport, Santa Maria Valley Railroad, agricultural and industrial operations, and roadway noise (e.g. U.S. 101 and major arterials) are the city's predominant noise sources.

Key Questions

The Vision and Guiding Principles represent consensus from community engagement, a shared Vision of the future and a common understanding of the direction the City needs to follow to achieve the Vision. However, the Vision and Guiding Principles do not address some important questions that will be answered during the process of evaluating Alternatives and presenting them to the community for feedback. Some of these questions include:

- Should the City grow outward (via annexation), inward (via infill development), or via some sort of hybrid approach?
- What is the desired mix of new housing types (e.g., single-family residential, multi-family residential, ADUs, etc.)?
- To what extent should the City aim to preserve its agricultural economy, and to what extent should it plan to transfer agricultural land into land uses that create jobs in the healthcare, education, industrial, and office-based sectors?
- How should the City balance roadway needs for all roadway users, including trucks, public transportation, pedestrians, private automobiles, and bicyclists?

Growth to Plan For

A critical component of Alternatives development is understanding how much housing and employment growth the Alternatives should plan for.

Though the General Plan horizon is 2045, this analysis anticipates growth needs through the year 2050 to align with Regional Housing Need Allocation (RHNA) cycles and growth projections produced by the Santa Barbara County Association of Governments (SBCAG).

This analysis was based on an understanding of how much housing and employment growth to plan for, which were projected based on potential RHNA allocations through the year 2050, SBCAG growth projections, as well as input from the Technical Advisory Committee (TAC), City staff, and the Department Advisory Group (DAG).

General Plan growth also takes into account growth the City has already planned, via Specific Plans and current pipeline projects. The net result, growth projections minus planned growth, yields housing and employment numbers the three land use Alternatives must at a minimum attain.

Projected Growth

Regional Housing Needs Allocation

Per SBCAG’s final RHNA sixth cycle allocation, the City of Santa Maria’s zoning must allow the production of 5,418 housing units by 2031.

The General Plan horizon (2045) will cover the sixth, seventh, and most of the eighth RHNA cycle. As a conservative estimate, the General Plan should account for three times the 2023 – 2031 cycle allocation totals, or about 16,200 units.

- Cycle 5, 2015 – 2023: 1,400 of 4,100 units permitted
- Cycle 6, 2023 – 2031: 5,418 units allocated
- Cycle 7, 2031 – 2039 cycle: Units to be determined
- Cycle 8, 2039 – 2047 cycle: Units to be determined

SBCAG Projections

Per Table 3, SBCAG projects a 33 percent increase in population in Santa Maria from 2020 through 2050. SBCAG does not project total number of housing units in the year 2050. However, assuming a housing vacancy of about 5 percent (consistent with vacancy rates in 2010 and 2020), based on the household projection of 44,100 in 2050, one can estimate a total of about 46,400 housing units are needed in Santa Maria in 2050 to accommodate the projected number of households.

With a total of about 30,400 units in 2020, a net increase of approximately 16,000 units are needed to house projected population growth by 2050. This is roughly consistent with the conservative estimate to accommodate three RHNA cycles, about 16,200 units. **Therefore, the General Plan land use Alternatives should identify adequate sites to allow for the development of at least 16,000 housing units by 2045.**

Table 3: SBCAG Growth Projections

	1990	2000	2010	2020	2030	2050
Population	61,552 ⁴	77,423 ⁴	99,553 ⁴	107,407 ¹	127,600 ³	143,100 ³
Households	19,995 ⁴	22,146 ⁴	26,908 ⁴	29,018 ¹	36,400 ³	44,100 ³
Housing Units	21,237 ⁴	22,847 ⁴	28,294 ⁴	30,430 ¹	-	-
Jobs	-	33,902 ²	38,489 ²	44,063 ²	47,310 ³	52,550 ³
Jobs/Housing Balance	-	1.48	1.36	1.45	-	-

Notes:

1. Source: California Department of Finance E-5 City/County Population and Housing Estimates, 1/1/20
2. Source: Longitudinal Employer-Household Dynamics (LEHD), 2010, 2017.
3. Source: SBCAG Regional Growth Forecast 2050 Santa Barbara County, 2019.
4. Source: California Department of Finance E-8 Historical Population and Housing Estimates for Cities, Counties, and the State, 1990, 2000, 2010.
5. Jobs in 1990 not available. Job totals in 2000 column are from the year 2002.

Regarding employment, SBCAG projects a total of 52,550 jobs in 2050, an increase in about 8,500 jobs over 2020 totals. Per the SBCAG’s 2050 job projections, as shown in Table 4, about 8% of SBCAG’s projected jobs in 2050 are in the industrial sector, 19% are in the commercial (retail) sector, 51% are in the commercial (office) sector, and about 22% are in the other/non-land use based sector, meaning they are not tied to a specific land use (such as construction). Using jobs-to-square foot conversion, this means Santa Maria needs about 14 million non-residential square feet total in 2050 to support this job growth.

However, feedback from the TAC and DAG indicated that a growth of 8,500 jobs by 2050 may not be enough new jobs to ensure a vibrant economy in Santa Maria, particularly when comparing this job growth to an increase in 16,200 housing units. 16,000 new jobs, which would result in a jobs-to-housing units balance of 1.2, was identified by the City as a more desirable amount of job growth. As of 2017, the balance was roughly 1.4 jobs per housing units. **Therefore, the City should plan for a minimum of 8,500 new jobs, with 16,000 jobs being the desired total, by 2050.**

Table 4: SBCAG Projected Jobs

Sector	Jobs ⁵	Approximate Building Square Footage ⁶
Commercial (Retail) ¹	10,068	3,020,400
Commercial (Office) ²	26,855	6,713,750
Industrial ³	4,223	4,323,000
Other/Non-Land Use Based ⁴	11,303	-
Total	52,550	14,057,150

Notes:

1. Commercial (retail) job sector includes retail trade; and leisure/hospitality sectors.
2. Commercial (office) job sector includes information; financial activities; professional and business services; education and health services; other services; and government sectors.
3. Industrial job sector includes manufacturing; wholesale trade; and transportation, warehousing, and utilities sectors.
4. Other/Non-Land Use Based job sector includes self-employed; natural resources/mining; and construction sectors.
5. Jobs source: SBCAG Regional Growth Forecast 2050 Santa Barbara County, 2019.
6. Square footage estimated based on the following job/Square Foot assumptions: 1 job per 1,000 industrial square feet; 1 job per 300 commercial/retail square feet, and 1 job per 250 office square feet.

Projected Development

Pipeline Projects

The land use Alternatives lay out a framework for accommodating 16,000 new housing units and a minimum of 8,500 new jobs. The City of Santa Maria already has a number of unbuilt projects in its pipeline, including 2,026 housing units and about 1.1 million square feet of non-residential development. Non-residential development could create an estimated 6,900 jobs, about half of SBCAG's projected job growth by the year 2050 and over 100% of the target of 8,500 new jobs¹

Specific Plans

The City of Santa Maria has a number of Specific Plans that are planned but not built out. Some of the housing and job growth needed by 2050 can be accommodated in these Specific Plan areas, reducing the need to find adequate sites for housing and jobs elsewhere in the city. **In total, there are an estimated 3,605 units and 16,200,000 non-residential square feet that can be built under current Specific Plans.** The 16,200,000 planned non-residential square feet will enable the City to make significant progress to achieve at least 8,500 jobs by 2050.² This square footage is comprised of projects in a variety of sectors, including office, industrial, and retail.

ADU/JADU Growth

Growth of accessory dwelling units (ADUs) and junior accessory dwelling units (JADUs) need to be considered when planning for growth of Santa Maria. Whereas the land use Alternatives will identify vacant or redevelopable parcels where new housing can be built as part of larger developments, ADUs and JADUs represent incremental housing growth on parcels where housing already exists. Thus, ADUs and JADUs must be factored in the growth calculation formula because they represent housing growth that is expected to occur over the General Plan horizon, but ADU and JADU growth differs from planned growth over the General Plan horizon because it is difficult to predict exact parcels where this growth may occur.

From April 2018 through June 2021, 266 ADUS or JADUS were built in the City, for about 88 per year. Based on an evaluation of ADU permitting history, about 1,300 units, or about 55 units per year, are estimated to be developed over the General Plan horizon. This decrease in permitting rates from recent totals is based on conversations with City staff and overall trends, developments per year due to the recent boom in ADU growth slowing and less applicable properties being able to develop ADUs over time.

Total Growth to Plan For

Based on an understanding of projections from SBCAG, input from the TAC and DAG, and an analysis of RHNA allocations, the General Plan should plan to accommodate a minimum of 16,000 new housing units and 8,500 (ideally 16,000) new jobs through the year 2050.

However, with planned growth in the City via pipeline projects and Specific Plans, the City already has plans in place to accommodate some of the necessary job and housing growth. In total, about 4,700

¹ Job totals calculated by Urban Footprint based on non-residential pipeline square footage.

² To produce at least 8,500 jobs the 16,200,000 square feet of employment land uses would average about 1,900 square feet per employee. 1,900 square feet per employee is higher than most industry standards of square feet per employee, therefore, 16,200,000 should provide sufficient capacity for at least 8,500 jobs.

housing units are anticipated to be built in the City in current pipeline projects or in Specific Plan areas. Factoring in projected growth of ADUs and JADUs yields about 1,300 additional units. With a total of 1,100,000 non-residential square feet currently in the development pipeline and about 16,200,000 non-residential square feet planned in the City via Specific Plans, the City should be able to achieve the minimum of 8,500 jobs needed.

Thus, the land use Alternatives need to accommodate a minimum of 9,270 housing units (see Table 5). The Alternatives do not need to accommodate a minimum number of jobs because pipeline and Specific Plan projects already plan for at least 8,500 jobs across a variety of job sectors. However, the Alternatives should still aim to ensure job diversity and achieve a net increase of close to 16,000 jobs to exceed SBCAG job projections and arrive at a jobs to housing ratio of 1.2.

Table 5: Minimum Residential Growth to Plan for

	Units
Minimum growth to accommodate	16,200
Minus	
Planned Growth	5,631
<i>Pipeline Projects</i>	2,026
<i>Unbuilt Specific Plans</i>	3,605
Minus	
Projected ADU and JADU Growth	1,300
Equals	
Remaining minimum growth to plan for	9,269

Introduction to Land Use Alternatives

Commonalities and Differences Across Alternatives

Three land use Alternatives were designed with a number of characteristics in common. These common characteristics are based on areas where there was consensus among the community; State and local laws; technical analysis; and the Vision and Guiding Principles document. These characteristics are described in Table 6.

Table 6: Commonalities Across Alternatives

Characteristic	Implementation in Alternatives and the General Plan
Consistency with Vision and Guiding Principles	All Alternatives are consistent with the Vision and Guiding Principles. The General Plan will include policies and actions to complement the Vision and Guiding Principles, specifically, the components of the Vision and Guiding Principles not explicitly addressed in the land use and mobility Alternatives.

Future conditions may differ from today	The Alternatives represent the best-possible guess to plan for a growing City in 2022, but there is no way to predict how conditions will change through 2050. Potential factors that may affect the viability of the General Plan in the future include changes to State law, the development approvals process, economic conditions, and more.
Same minimum growth targets	All land use Alternatives will accommodate a minimum growth of 16,200 housing units and 8,500 jobs.
Specific Plan growth	Most Specific Plans will continue to develop as anticipated.
Growth assumed in vacant and opportunity sites	Growth within City limits for all three land use Alternatives is assumed to occur on sites that are currently vacant and sites that have opportunity for redevelopment. Opportunity sites were selected based on feedback from City staff and via an analysis of building value to land value. Vacant and opportunity sites are assumed to redevelop in all three Alternatives.
Land use designations will be the same in most parts of the city	Most areas of the city will retain the existing General Plan land use designation across the three land use Alternatives.
General Plan land use designations may change for parcels where existing land use differs from General Plan land use	General Plan Land Use designations will be adjusted for selected parcels where existing or proposed land use necessitates a change in designation (for instance, a parcel used for residential that currently has a commercial designation may be changed to a residential designation).
Increase in infrastructure capacity	Infrastructure capacity needs to be improved throughout the City. It is assumed that infrastructure capacity will be increased to accommodate the growth pattern laid out in the three land use Alternatives. As part of the technical analysis of the Preferred Plan, infrastructure improvement needs will be analyzed to ensure growth is adequately served by water, wastewater, and stormwater infrastructure.
Public facilities, parks, and public services are needed for a growing city	Expansion of public facilities, parks, and community services are assumed to serve the growing community.
Emphasis on “complete neighborhoods”	All three land use Alternatives would aim to create more “complete neighborhoods,” where residents have convenient access to daily amenities, such as shopping, healthy food, and parks and public facilities.
Emphasis on addressing health and environmental justice	The Alternatives address SB 1000 requirements, including promoting physical activity in disadvantaged communities, promoting food access in disadvantaged communities, and promoting public facilities in disadvantaged communities, by improving access to parks and public spaces throughout the city and developing complete neighborhoods. Policies in the General Plan will further prioritize improvements in disadvantaged neighborhoods.

The Alternatives differ from each other based on a number of characteristics. These characteristics, outlined below, lend to the creation of three distinct land use Alternatives and will enable the community and decision-makers to weigh trade-offs between the three Alternatives.

- **Annexation.** Two of the three land use Alternatives assume annexation of land beyond current City limits.

- **Agricultural and open space preservation.** The land use Alternatives will preserve different amounts of agricultural and open space land. For the two Alternatives that assume annexation, agricultural and open space land outside of City limits is assumed to be developed.
- **Development densities and intensities.** The land use Alternatives assume different densities and intensities for new development in different parts of the City and beyond City limits.
- **Area 9 Specific Plan.** The Area 9 Specific Plan is anticipated to develop as planned in one of the three land use Alternatives. The other Alternatives assume revisions to allow for residential growth.
- **Infrastructure.** Infrastructure upgrades are needed in different locations in the City and outside City limits, depending on the land use Alternative.
- **Transportation.** Transportation networks will need to be adapted to each land use Alternative.
- **Location of new public facilities, parks, and services.** The provision of new public facilities, parks, and services will vary among the three land use Alternatives, based on where population growth is expected to occur.

Land Use Designations

In order to better meet the vision of the community, the updated General Plan will have new land use designations. Some will be similar to existing designations from the current General Plan and some designations will introduce new development opportunities. Land use designations are shown in Table 7.

The land use designations are divided into five basic categories:

1. **Residential** designations for the residential-only areas of the city.
2. **Mixed use** designations to allow for a mix of uses in an area.
3. **Commercial** designations to provide areas for retail, offices and service uses.
4. **Industrial/Airport** designations to allow for a range of job-producing uses including light industrial, manufacturing, and airport operations.
5. **Public and Open Space** uses including schools, parks, open spaces, and agricultural uses
6. **Planned Development** for areas covered by the Downtown Specific Plan and planned annexation areas.

Relation to State Law

Per State law, General Plan land use regulations must be consistent with zoning. Currently, the zoning districts and General Plan designations are not consistent. Therefore, following the General Plan Update process, a comprehensive zoning code update may be necessary to ensure consistency.

State law requires that General Plan land use designations provide a measurement of the maximum development intensity allowed within each designation. According to State law, land use designations must identify the allowed uses and the development intensity (measured in dwelling units per acre, floor area ratio (FAR) or jobs/residents per acre).

Relation to Existing General Plan Land Use Designations

The land use designations in the land use Alternatives make some changes to existing General Plan land use designations. These include the following changes:

- Eliminate the Medium Density Residential -10 (MDR-10) General Plan land use designation and reassign all parcels currently with this designation to Medium Density Residential -12 (MDR 12) to allow up to 12 du/ac.
- Revise the existing High Density Residential (HDR) designation to allow up to 30 du/ac in Alternative A and 35 du/ac in Alternatives B and C from 22 du/ac. This increase in du/ac allowance is consistent with State affordable housing law.
- Create three new land use designations: Broadway Mixed Use (BMU), Main Mixed Use (MMU) for Alternatives B and C; and Planned Annexation Area (PA) for Alternatives A and C.
- The existing Central District 1 designation has been superseded by the area in the Downtown Specific Plan. Rename the current Central District 2 designation to Central District.
- Land use descriptions and uses have been lightly revised.

Relation to Zoning

Zoning regulations must be within the range of the allowed intensity and uses found in the General Plan. Although land use designations and zoning districts must be compatible, they are not necessarily identical; where the documents differ, the General Plan takes precedence. Unlike the General Plan land use designations, which are broad in scope, the zoning districts provide more specific guidance about allowed and prohibited uses (including conditional uses), as well as dimensional requirements such as building setbacks, parking standards, and building heights. Following the General Plan Update, updates to the Zoning Ordinance will be necessary to ensure compliance.

Relation to Future Planning in Annexation Areas



Two of the Alternatives assume annexation of land outside of City limits. This land is assigned a Planned Annexation Area land use designation. For these two Alternatives, a mix of land uses, density, and intensity have been prescribed, based on jobs and housing targets, community and City staff input, land use compatibility, and environmental constraints. Future specific or master planning efforts related to uses, building design, public facilities, transportation, and infrastructure is expected to occur in the future, following adoption of the General Plan Update.





Land Use Designations







Table 7: Land Use Designations



Designation	Description
Residential	
Residential Agricultural (RA)	To create a transition area between agricultural and strictly urban uses, as well as provide for a particular residential lifestyle. <u>Allowed uses:</u> Low-density dwelling units, noncommercial agricultural activities, the keeping of horses and certain commercial agricultural activities on larger (suggested minimum of 5- to 10-acre) parcels.

	<p><u>Density:</u> Max 2 du/ac <u>Height maximum:</u> 25 feet <u>Alternatives:</u> All</p>
<p>Lower-Density Residential (LWDR-4)</p> 	<p>Single-family detached dwelling units with overall (average) density not to exceed four dwelling units per acre with variable lot sizes for single family detached units up to one acre in size. <u>Allowed uses:</u> Single-family detached dwelling units with variable lot sizes for single family detached units up to one acre in size. <u>Density:</u> Max 4 du/ac <u>Height maximum:</u> 30 feet <u>Alternatives:</u> All</p>
<p>Low Density Residential (LDR-5)</p> 	<p>To encourage new areas with overall densities responsive to the economic considerations of providing new housing, on a wide range of standard sized lots. providing the amenities and open spaces associated with traditional single-family areas and stabilizing existing areas by discouraging intensification of density. <u>Allowed uses:</u> Single-family detached dwelling units with variable lot sizes for single-family detached units up to one-fourth acre in size. <u>Density:</u> Max 5 du/ac <u>Height maximum:</u> 30 feet <u>Alternatives:</u> All</p>
<p>Low Medium Density Residential (LMDR-8)</p> 	<p>To encourage densities that are responsive to the economic considerations of providing affordable single-family housing on small lots while at the same time maintaining adequate individual private open space, design flexibility, and the character of a single-family neighborhood. <u>Allowed uses:</u> Single-family detached dwelling units, with variable lot sizes for single-family detached units. This development type would usually require zero side yard development to maximize private, usable yards. Developments without zero side yards may require the larger lots and setbacks typically found in the R-1 zones. <u>Density:</u> Max 8 du/ac <u>Height maximum:</u> 30 feet <u>Alternatives:</u> All</p>
<p>Medium Density Residential (MDR-12)</p> 	<p>To encourage new development while stabilizing existing development. Allows a mixture of unit types. while maintaining the feeling of a single-family neighborhood. To encourage reinvestment in older areas, and provide a land conservation measure by inducing development away from yet undeveloped areas. <u>Allowed uses:</u> Single-family, detached and attached, duplexes; triplexes; and larger multi-family complexes. <u>Density:</u> Max 12 du/ac <u>Height maximum:</u> 30 feet <u>Alternatives:</u> All</p> <p><i>Note: The existing Medium Density Residential – 10 (MDR-10) designation would be eliminated and all parcels with this designation to would be reassigned to Medium Density Residential -12 (MDR-12).</i></p>
<p>High Density Residential (HDR-35 in Alternatives B and C, HDR-30 in Alternative A)</p>	<p>To provide for an urban residential environment, preferably close to shopping facilities and existing activity centers, as well as provide an incentive for reinvestment in older established areas. <u>Allowed uses:</u> Duplexes, triplexes, and larger multi-family complexes. <u>Density:</u> Max 35 du/ac in Alternatives B and C (HDR-35), maximum 30 du/ac in Alternative A (HDR-30) <u>Height maximum:</u> 35 feet <u>Alternatives:</u> All</p>

	<p><i>Note: The existing High Density Residential (HDR) designation would be revised to allow up to 30 du/ac in Alternative A and 35 du/ac in Alternatives B and C from 22 du/ac. This increase in du/ac allowance is consistent with State affordable housing law.</i></p>
<p>Mixed Use</p>	
<p>Main Mixed Use (MMU)</p>	<p>To allow for multi-story, multi-use development along Main Street contextual with adjacent residential uses. The intent is to allow for the creation of commercial uses mixed with multi-family housing to create opportunities to live on the Main Street corridor and encourage activity and vitality on Main Street. Uses may be mixed horizontally or vertically, though active ground floor uses, such as restaurants and retail, are encourage. A mix of uses is not required in this district. Design requirements, such as building setbacks, may be employed to transition to residential uses on adjacent streets.</p> <p><u>Allowed uses:</u> Retail, restaurants, service commercial (such as banks or real estate offices), service establishments (such as medical clinics and beauty shops), office buildings, hotels, multi-family housing, townhomes, duplexes.</p> <p><u>Density:</u> up to 70 du/ac in Alternative B and 35 du/ac in Alternative C.</p> <p><u>Assumed intensity:</u> 1.1 FAR in Alternative B and 1.6 FAR in Alternative B, inclusive of residential and non-residential uses.</p> <p><u>Height maximum:</u> 70 feet</p> <p><u>Alternatives:</u> B and C</p> <p><i>Note: This is a new land use designation.</i></p>
<p>Broadway Mixed Use (BMU)</p>	<p>To allow for multi-story, multi-use development along Broadway. The intent is to allow for the creation of commercial uses mixed with multi-family housing to create opportunities to live on the Broadway corridor and encourage activity and vitality Downtown. Uses may be mixed horizontally or vertically, though active ground floor uses, such as restaurants and retail, are encouraged on the ground floor. A mix of uses is not required in this district.</p> <p><u>Allowed uses:</u> Retail, restaurants, entertainment, bars, service commercial (such as banks or real estate offices), service establishments (such as medical clinics and beauty shops), office buildings, hotels, multi-family housing.</p> <p><u>Density:</u> Up to 70 du/ac in Alternative B and 35 du/ac in Alternative C.</p> <p><u>Assumed intensity:</u> 1.1 FAR in Alternative B and 1.6 FAR in Alternative C, inclusive of residential and non-residential uses.</p> <p><u>Height maximum:</u> 70 feet</p> <p><u>Alternatives:</u> B and C</p> <p><i>Note: This is a new land use designation.</i></p>
<p>Central District (CD)</p> 	<p>To encourage pedestrian activities and amenities while revitalizing the Downtown core. A variety of mixed uses within multi-storied buildings with residences and office uses located on the upper floors and retail uses located on the first floor. An enhanced street environment would create a pleasant walking environment.</p> <p><u>Allowed uses:</u> Mixed Uses (residential, office, retail), services, and assembly. Residential densities would include a maximum of 40 dwelling units per acre.</p> <p><u>Density:</u> 40 du/ac</p> <p><u>Assumed intensity:</u> 0.5 FAR, or 3.0 FAR with residential</p> <p><u>Height maximum:</u> 40 feet</p> <p><u>Alternatives:</u> All</p>

	<p><i>Note: The existing Central District 1 designation has been superseded by the area in the Downtown Specific Plan. The existing Central District 2 designation has been renamed to "Central District."</i></p>
<p>Commercial</p>	
<p>Community Commercial (CC)</p> 	<p>To include the majority of retail uses outside the central core, particularly along the lineal development corridors which have emerged. The majority of these uses would be geared to the area-wide market.</p> <p><u>Allowed uses:</u> Variety of retail uses, excluding "heavy", land extensive or quasi-industrial commercial uses such as lumber yards, agricultural equipment yards, pipe supply works, etc.</p> <p><u>Density:</u> 30 du/ac in Alternative A with Mixed Use Overlay, 35 du/ac in Alternatives B and C with Mixed Use Overlay</p> <p><u>Assumed intensity:</u> 0.5 FAR, or 3.0 FAR with residential</p> <p><u>Height maximum:</u> 70 feet</p> <p><u>Alternatives:</u> All</p>
<p>Commercial/ Professional Office (CPO)</p> 	<p>To provide areas for offices, which may be compatible with a range of other uses.</p> <p><u>Allowed uses:</u> Office development for the following services: medical, legal, travel agencies, insurance, and real estate services, as well as a certain complementary commercial uses.</p> <p><u>Density:</u> 30 du/ac in Alternative A with Mixed Use Overlay, 35 du/ac in Alternatives B and C with Mixed Use Overlay</p> <p><u>Assumed intensity:</u> 0.35 FAR, 1.1 FAR with residential</p> <p><u>Height maximum:</u> 35 feet</p> <p><u>Alternatives:</u> All</p>
<p>Freeway Service (FS)</p> 	<p>To accommodate the needs of the traveling public along major transportation corridors.</p> <p><u>Allowed uses:</u> Motels, service stations, restaurants, and rest stops.</p> <p><u>Height maximum:</u> 40 feet</p> <p><u>Assumed intensity:</u> 0.25 FAR</p> <p><u>Alternatives:</u> All</p>
<p>Neighborhood Commercial (NC)</p> 	<p>To provide areas which offer convenience goods and services to local residents without disrupting the residential character of an area. These areas are intended to be small in size and not geared to providing a multitude of more specialized goods and services serving a community-wide or regional market.</p> <p><u>Allowed uses:</u> Supermarkets, convenience grocery stores, drug stores, laundromats, bakeries, shoe repair shops.</p> <p><u>Density:</u> 30 du/ac in Alternative A with Mixed Use Overlay, 35 du/ac in Alternatives B and C with Mixed Use Overlay</p> <p><u>Assumed intensity:</u> 0.3 FAR, 1.6 FAR with residential (Alternative A) and 1.1 FAR with residential (Alternatives B and C)</p> <p><u>Height maximum:</u> 30 feet</p> <p><u>Alternatives:</u> All</p>
<p>Industrial/Airport</p>	
<p>Light Industrial (LI)</p> 	<p>To accommodate industrial uses which contain the process primarily within the building, do not generate negative environmental impacts, and which are most compatible with adjacent nonindustrial uses.</p> <p><u>Allowed uses:</u> Research facilities, light assembly plants, non-public-oriented-offices and industrial support offices, tractor sales and display when the property is adjacent to the freeway, and churches on a temporary basis.</p> <p><u>Assumed intensity:</u> 0.4 FAR</p> <p><u>Height maximum:</u> 35 feet</p> <p><u>Alternatives:</u> All</p>

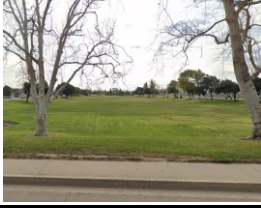
<p>General Industrial (GI)</p> 	<p>To provide areas for all types of heavy industrial uses, but particularly those which need to be separated from other land uses because of the impacts associated with these activities, such as heavy truck traffic, noise, odor, or dust.</p> <p><u>Allowed uses:</u> Range of industrial uses, including heavy manufacturing, heavy trucking operations.</p> <p><u>Assumed intensity:</u> 0.5 FAR</p> <p><u>Height maximum:</u> 40 feet</p> <p><u>Alternatives:</u> All</p>
<p>Heavy Commercial/ Manufacturing (HCM)</p> 	<p>To permit activities that manufacture and retail on the same site as well as other heavy commercial uses which may be land extensive, require transport of materials by heavy truck, require large loading and docking areas, and where the possibilities of heavy noise generation exist.</p> <p><u>Allowed uses:</u> Lumberyards, boat works, warehouses, building supply dealers, mobile home sales, farm equipment sales, equipment repair, and churches within an existing building.</p> <p><u>Assumed intensity:</u> 0.5 FAR</p> <p><u>Height maximum:</u> 40 feet</p> <p><u>Alternatives:</u> All</p>
<p>Airport Service (AS)</p> 	<p>To provide a broad category facilitating the airport and airport-related commercial and industrial uses not adversely affected by airport operations, to provide for specific areas for aircraft operation and navigation aids, and to minimize the hazard to safe landing and take-off of aircraft.</p> <p><u>Allowed uses:</u> Full range of uses, including airport operation and support activities.</p> <p><u>Assumed intensity:</u> 0.6 FAR</p> <p><u>Alternatives:</u> All</p>
<p>Public and Open Space</p>	
<p>Primary Agricultural Open Space (AOS-1)</p> 	<p>To preserve certain areas for present and future agricultural production. It also provides for limited residential uses.</p> <p><u>Allowed uses:</u> Intensive crop agricultural uses. All land classified as prime agricultural (Class I and II soils).</p> <p><u>Alternatives:</u> All</p>
<p>Secondary Agricultural Open Space (AOS-2)</p> 	<p>To preserve certain areas for present and future agricultural production. It also provides for limited residential uses.</p> <p><u>Allowed uses:</u> Less intensive agricultural uses, including grazing. Includes some lands that are not prime agricultural but are an agricultural buffer and are not now considered suitable for urban expansion.</p> <p><u>Alternatives:</u> All</p>
<p>Conservation Open Space (COS)</p> 	<p>To protect natural resources, provide scenic protection, act as an urban agriculture buffer, allow mineral extraction, and act as a safety buffer between the urban land uses and the levee. It also provides for limited residential uses.</p> <p><u>Allowed uses:</u> Includes areas subject to flood hazard, significant groundwater recharge areas, well farms, areas adjacent to creekbeds, areas of surface and sub-surface mineral extraction, levee buffer, airport safety areas, and publicly owned landscaped areas.</p> <p><u>Alternatives:</u> All</p>
<p>Recreational Open Space (ROS)</p>	<p>To provide for recreation and scenic protection and provide scenic areas along railroad rights-of-way</p>

	<p><u>Allowed uses:</u> Existing and proposed recreational facilities, including neighborhood, community, and regional parks; bikeways; equestrian trails; jogging paths; selected public utility and railroad rights-of-way and associated uses where the right-of-way corresponds to the adopted Bikeways Plan; and publicly owned and operated sanitary landfill operations that have the potential for reclamation and development into the aforementioned recreational facilities.</p> <p><u>Alternatives:</u> All</p>
<p>Community Facilities (CF)</p> 	<p>To provide for necessary facilities for use by the public.</p> <p><u>Allowed uses:</u> Public facilities, including schools and government buildings.</p> <p><u>Height maximum:</u> 35 feet</p> <p><u>Alternatives:</u> All</p>
<p>Planned Development</p>	
<p>Downtown Specific Plan (SP)</p>	<p>To encourage implementation of the Downtown Specific Plan.</p> <p><u>Allowed uses:</u> The Downtown Specific Plan designates all land uses, and the geographic boundaries of each use, allowed in its boundary.</p> <p><u>Density:</u> Up to 70 du/ac in Alternative A, 100 du/ac in Alternative B, and 70 du/ac in Alternative C.</p> <p><u>Assumed intensity:</u> 0.5, up to 3.0 FAR with residential.</p> <p><u>Height maximum:</u> 40 to 70 feet, depending on Specific Plan district.</p> <p><u>Alternatives:</u> All</p>
<p>Planned Annexation Area (PA)</p>	<p>To encourage comprehensive planning and urban design flexibility for large annexation land areas (over 60 acres) through the adoption of a specific plan or master plans following the General Plan Update process, as the City proceeds with annexation. Such flexibility allows the City to adopt a set of land use specifications and implementation programs tailored to the unique characteristics of each area.</p> <p><u>Allowed uses:</u> The specific plan or master plan will designate all land uses, and the geographic boundaries of each use, allowed in each area. Potential uses include residential (single-family homes, townhomes, duplexes, multi-family), public and institutional, parks and recreation, and non-residential (industrial, office, retail, services, etc.)</p> <p><u>Assumed density:</u> Up to about 10 du/ac. Note, maximum density will be defined in the General Plan.</p> <p><u>Assumed intensity:</u> Up to about 0.2 FAR. Note, maximum FAR will be defined in the General Plan.</p> <p><u>Alternatives:</u> A and C</p> <p><i>Note: This is a new land use designation.</i></p>
<p>Notes:</p> <ol style="list-style-type: none"> 1. Single-family zones are subject to SB9, which was passed in 2021. This law allows for parcels in single-family zones to be subdivided and duplexes built on each lot. 2. The maximum residential density of any residential land use designation may be exceeded to complement General Plan Housing Element policy (in accordance with the City's inclusionary housing ordinance and density bonus provisions of Section 65915 of the California Government Code). 3. Intensities given in this Table represent assumed FARs used in Urban Footprint growth projections. These were based on average FARs of current development, as calculated by City staff. The City does not currently regulate intensity in its zoning or the General Plan. 	

Alternative A: Annexation

Vision

The vision for this Alternative is to continue the City’s existing pattern of growth within City limits, while annexing about 1,770 acres to accommodate new housing and employment growth. New residential neighborhoods outside City limits would be “complete neighborhoods,” where residents have easy access to parks, public facilities, and neighborhood commercial within an easy walk or bike. Employment growth in annexation areas would create a range of jobs, including those in the industrial, office, and retail sectors. The annexation scenario would create focus new employment uses near US-101 and near existing employment areas. New employment areas near Marian Regional Medical Center and Hancock College would create opportunity for expansion of these campuses, or co-location of complementary land uses, like medical offices, housing, and retail. New parks and public facilities would be primarily located in annexed land outside of City limits, where population is expected to grow most significantly.

Key Drivers

The key drivers of this Alternative were identified based on community engagement and technical analysis. They are as follows:

- The City has a history of growth by expanding outward, and this Alternative would continue the historical pattern of outward expansion.
- The City cannot accommodate needed growth within City limits without significant changes to allowed building form (e.g., height, density). This Alternative would continue the existing scale and pattern of development within City limits.

Land Use Pattern

Proposed Changes from the Existing General Plan

This Alternative would differ from the land use pattern established in the existing General Plan, primarily by expanding City limits outward. Compared to the existing General Plan, this Alternative would:

- Create a larger General Plan Planning Area by assuming annexation of land outside City limits.
 - To the east of City limits, the annexation area would be roughly bordered by Vineyard Trail Road to the south, US-101 to the west, Main Street to the north, and Rosemary Road to the east. The annexation area would also include land bordered by Main Street to the south, Panther Drive to the west, and the Santa Maria River to the north and east.
 - On the west side of the city, this Alternative would annex land to the north of City limits between E Street and Hanson Way for industrial use.
- Create one new land use alternative: Planned Annexation Area (PA).
- Revise the High Density Residential (HDR) designation to allow up to 30 du/ac.

Land Use Mix

The proposed land use mix of Alternative A: Annexation, is shown in Table 8 and Figure 4.

Table 8: Alternative A Land Use Mix

Designation	Acres	Percent
Residential	4,142	27.1%
Lower-Density Residential (LWDR-4)	478	3.1%
Low-Density Residential (LDR-5)	2,098	13.7%
Low-Medium Density Residential (LMDR-8)	515	3.4%
Medium Density Residential (MDR-12)	530	3.4%
High Density Residential (HDR-30)	521	3.4%
Mixed Use	11	0.1%
Central District (CD)	11	0.1%
Commercial	1,116	7.3%
Community Commercial (CC)	784	5.1%
Commercial/Professional Office (CPO)	272	1.8%
Freeway Service (FS)	34	0.2%
Neighborhood Commercial (NC)	26	0.2%
Industrial/Airport	4,083	26.7%
Light Industrial (LI)	1,488	9.7%
General Industrial (GI)	409	2.7%
Heavy Commercial/Manufacturing (HCM)	709	4.6%
Airport Service (AS)	1,477	9.7%
Public and Open Space	3,904	25.6%
Primary Agricultural Open Space (AOS-1)	66	0.4%
Secondary Agricultural Open Space (AOS-2)	929	6.1%
Conservation Open Space (COS)	50	0.3%
Recreation Open Space (ROS)	1,638	10.7%
Community Facilities (CF)	1,221	8.0%
Planned Development	2,020	13.2%
Downtown Specific Plan (DSP)	197	1.3%
Planned Annexation Area (PAA)	1,823	11.9%
Total	15,275	100%
Note: Numbers may not add due to rounding.		

Figure 4: Alternative A Land Use Mix

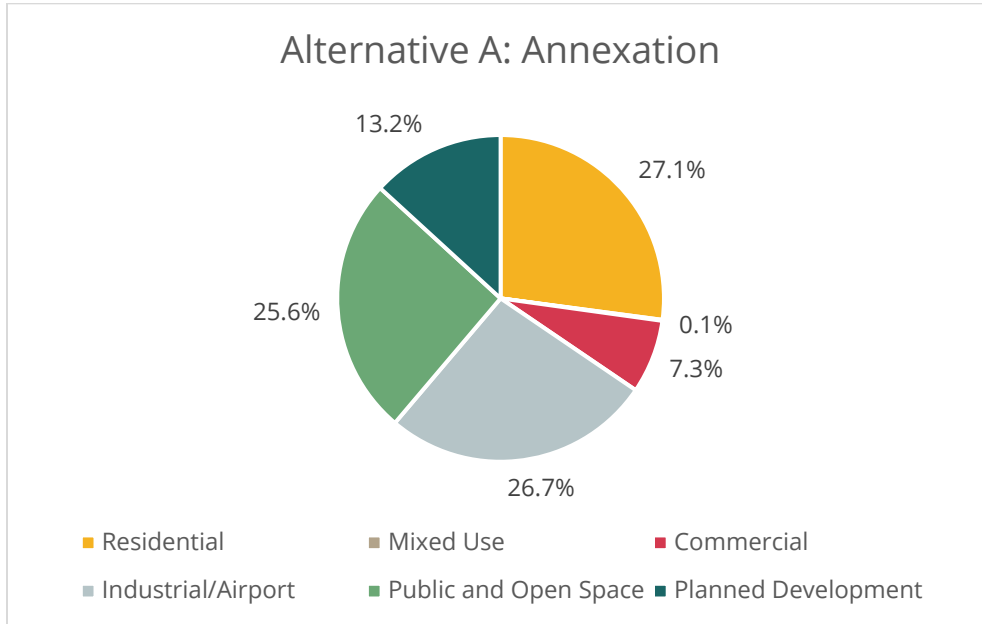

Land Use Map

Figure 5 shows the distribution of land uses for Alternative A: Annexation throughout the city.

Figure 5: Alternative A Land Use

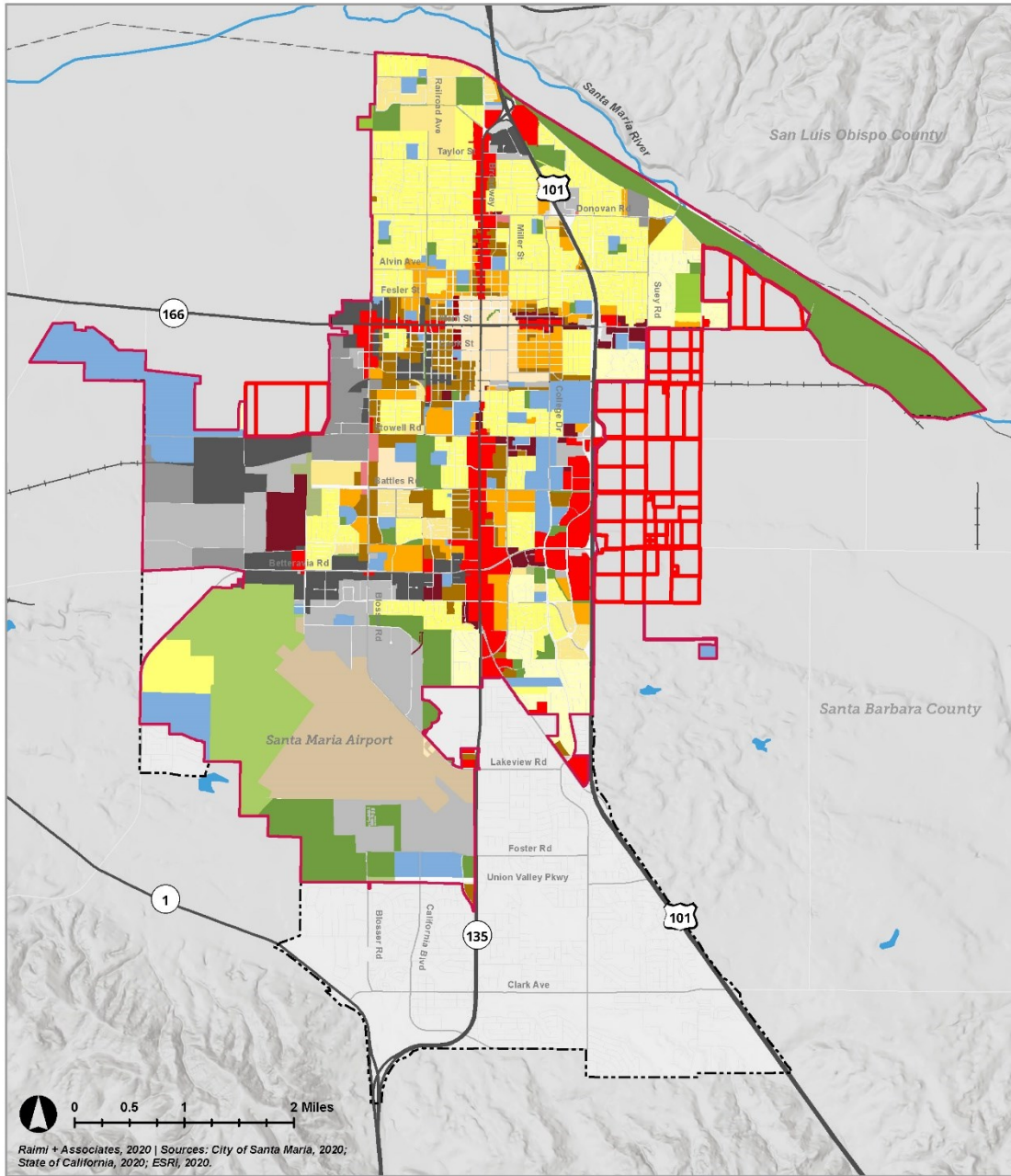

Proposed Land Use	
■ Primary Agricultural Open Space (AOS-1)	■ Low Medium Density Residential (LMDR-8)
■ Secondary Agricultural Open Space (AOS-2)	■ Low Density Residential (LDR-5)
■ Conservation Open Space (COS)	■ Lower-Density Residential (LWDR-4)
■ Recreational Open Space (ROS)	■ Community Commercial (CC)
■ Community Facilities (CF)	■ Central District (CD)
■ High Density Residential (HDR-30)	■ Commercial/Professional Office (CPO)
■ Medium Density Residential (MDR-12)	■ Neighborhood Commercial (NC)
	■ General Industrial (GI)
	■ Heavy Commercial/Manufacturing (HCM)
	■ Light Industrial (LI)
	■ Freeway Services (FS)
	■ Airport Services (AS)
	■ Specific Plan (SP)
	■ Planned Annexation (PA)

Alternative B: City Infill

Vision

This Alternative would accommodate new residential and job growth entirely within existing City limits. Most growth would be focused along the Main Street and Broadway corridors and in the few remaining large vacant and opportunity sites throughout the city. This Alternative would assume revisions to the Area 9 Specific Plan, accommodating new housing growth, commercial, and industrial uses. Transportation improvements would be focused within City limits, particularly along the Main Street and Broadway corridors, where most new growth is expected to occur. However, transportation improvements would also be needed to connect areas of major growth, such as Area 9, with the core of the city. Downtown would be a focal point of this Alternative, where more residential and employment growth would lead to more activity and vibrancy. Downtown would be complemented with new plazas, gathering spaces, and attention to urban design, while new parks and public facilities would be distributed throughout the city where growth is expected to occur and need exists.

Key Drivers

The key drivers of this Alternative were identified based on community engagement and technical analysis. They are as follows:

- This Alternative would be consistent with the pattern of growth assumed in SBCAG’s Regional Transportation Plan/Sustainable Communities Strategy, which proposes densifying the Main Street and Broadway corridors where high-frequency transit exists.
- It is not guaranteed that the City will annex land, therefore, this Alternative would not require annexation.
- This Alternative would prioritize infill development, and in doing so would preserve farmland and open space outside City limits.
- This Alternative would create more opportunities for living, working, and gathering Downtown

Land Use Pattern

Proposed Changes from the Existing General Plan and Other Plans

This Alternative would differ from the land use pattern established in the existing General Plan and existing Specific Plans. Compared to the existing General Plan and existing Specific Plans, this Alternative would:

- Revise the High Density Residential (HDR) designation to allow up to 35 du/ac.
- Require revisions to the Downtown Specific Plan, Entrada Specific Plan, and the Area 9 Specific Plan to allow new uses and development density/intensity.
- Create two new land use designations, Broadway Mixed Use (BMU) and Main Mixed Use (MMU).
- Require revision of the existing Mixed-Use Ordinance to allow up to 35 du/ac.
- Revise the High Density Residential (HDR) designation to allow up to 35 du/ac.

Land Use Mix

The proposed land use mix of Alternative B: City Infill, is shown in Table 9 and Figure 6.

Table 9: Alternative B Land Use Mix

Designation	Acres	Percent
Residential	4,317	32.1%
Lower-Density Residential (LWDR-4)	590	4.4%
Low-Density Residential (LDR-5)	2,065	15.3%
Low-Medium Density Residential (LMDR-8)	515	3.8%
Medium Density Residential (MDR-12)	568	4.2%
High Density Residential (HDR-35)	579	4.3%
Mixed Use	484	3.6%
Main Street Mixed Use (MMU)	88	0.7%
Broadway Mixed Use (BMU)	385	2.9%
Central District (CD)	11	0.1%
Commercial	625	4.6%
Community Commercial (CC)	356	2.6%
Commercial/Professional Office (CPO)	207	1.5%
Freeway Service (FS)	36	0.3%
Neighborhood Commercial (NC)	26	0.2%
Industrial/Airport	4,007	29.8%
Light Industrial (LI)	1,474	11.0%
General Industrial (GI)	400	3.0%
Heavy Commercial/Manufacturing (HCM)	656	4.9%
Airport Service (AS)	1,477	11.0%
Public and Open Space	3,825	28.4%
Primary Agricultural Open Space (AOS-1)	66	0.5%
Secondary Agricultural Open Space (AOS-2)	850	6.3%
Conservation Open Space (COS)	50	0.4%
Recreation Open Space (ROS)	1,638	12.2%
Community Facilities (CF)	1,221	9.1%
Planned Development	197	1.5%
Downtown Specific Plan (DSP)	197	1.5%
Planned Annexation Area (PAA)	0	0%
Total	13,455	100%
Note: Numbers may not add due to rounding.		

Figure 6: Alternative B Land Use Mix

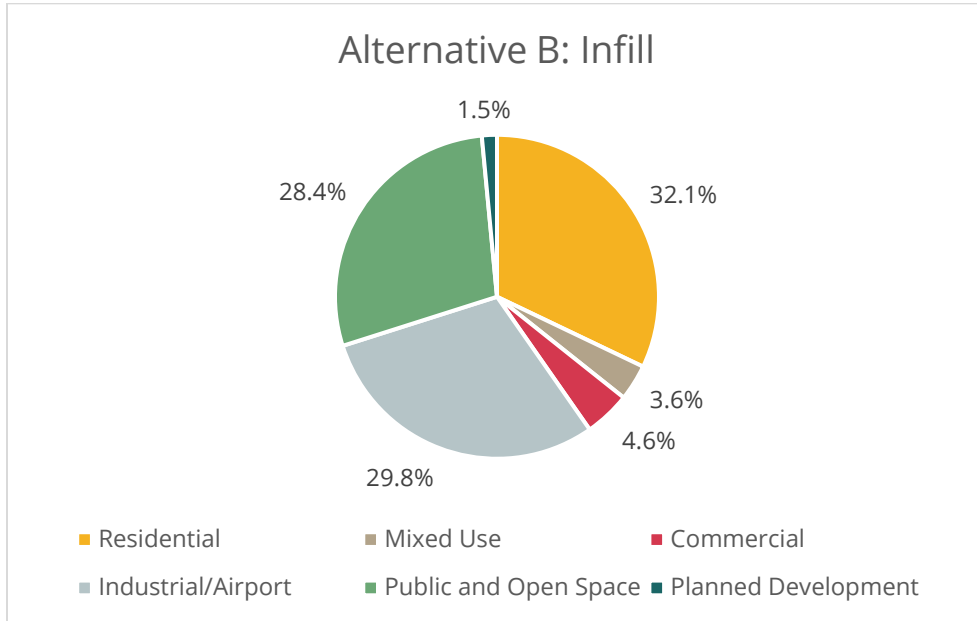

Land Use Map

Figure 7 shows the distribution of land uses for Alternative B: City Infill throughout the city.

Figure 7: Alternative B Land Use

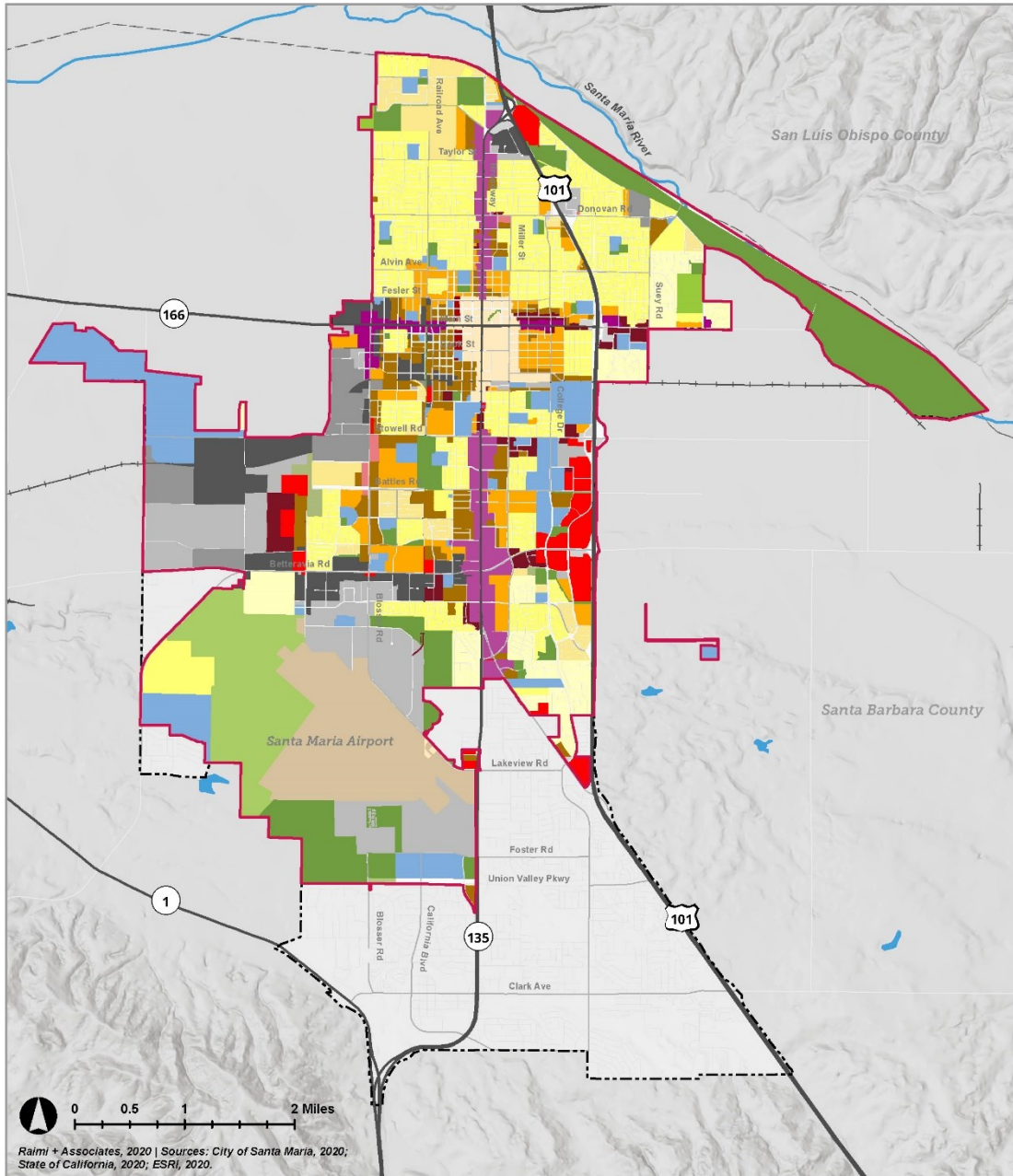

- | Proposed Land Use | |
|---|---|
| ■ Primary Agricultural Open Space (AOS-1) | ■ Low Medium Density Residential (LMDR-8) |
| ■ Secondary Agricultural Open Space (AOS-2) | ■ Low Density Residential (LDR-5) |
| ■ Conservation Open Space (COS) | ■ Lower-Density Residential (LWDR-4) |
| ■ Recreational Open Space (ROS) | ■ Community Commercial (CC) |
| ■ Community Facilities (CF) | ■ Broadway Mixed Use (BMU-70) |
| ■ High Density Residential (HDR-35) | ■ Main Street Mixed Use (MMU-70) |
| ■ Medium Density Residential (MDR-12) | ■ Central District (CD) |
| | ■ Commercial/Professional Office (CPO) |
| | ■ Neighborhood Commercial (NC) |
| | ■ General Industrial (GI) |
| | ■ Heavy Commercial/Manufacturing (HCM) |
| | ■ Light Industrial (LI) |
| | ■ Freeway Services (FS) |
| | ■ Airport Services (AS) |
| | ■ Specific Plan (SP) |

Alternative C: Hybrid

Vision

This Alternative allows increased residential development density within City limits, including along Main Street and Broadway and on major opportunity sites. This Alternative assumes annexation, though not as much land would be annexed in this alternative (about 720 acres) as Alternative A: Annexation due to intensification of land uses within City limits. New residential neighborhoods outside City limits would be “complete neighborhoods,” where residents have easy access to parks, public facilities, and neighborhood commercial within an easy walk or bike. New parks and public facilities would complement new residential development outside City limits. Annexed land would be focused along US-101 and near Marian Regional Medical Center. Transportation improvements would simultaneously accommodate growth within City limits and in the annexation areas.

Key Drivers

The key drivers of this Alternative were identified based on community engagement and technical analysis. They are as follows:

- This Alternative would be consistent with the pattern of growth assumed in SBCAG’s Regional Transportation Plan/Sustainable Communities Strategy, which proposes densifying the Main Street and Broadway corridors, though less consistent than Alternative B: City Infill.
- This Alternative would facilitate infill development, though less infill development than Alternative B: City Infill.
- This Alternative would preserve more farmland and open space outside City limits than Alternative A: Annexation.
- This Alternative would create more opportunities for living, working, and gathering Downtown.
- The City has a history of growth by expanding outward, and this Alternative would continue the historical pattern of outward expansion.
- This Alternative would slightly increase the existing scale and pattern of development within City limits.

Land Use Pattern

Proposed Changes from the Existing General Plan and Other Plans

This Alternative would differ from the land use pattern established in the existing General Plan and existing Specific Plans. Compared to the existing General Plan and existing Specific Plans, this Alternative would:

- Create a larger General Plan Planning Area by assuming annexation of land outside City limits.
 - To the east of City limits, the annexation area would be roughly bordered by Vineyard Trail Road to the south, US-101 to the west, Main Street to the north, and Suey Road to the east. The annexation area would also include land bordered by Jones Street to the south, Suey Road to the west, Main Street to the north, and Panther Drive to the east.

- Require revisions to the Downtown Specific Plan, Entrada Specific Plan, and Area 9 Specific Plan to for allow new uses and development density/intensity.
- Create three new land use designations, Broadway Mixed Use (BMU), Main Mixed Use (MMU), and Planned Annexation Area (PA).
- Require revision of the existing Mixed Use Ordinance to allow up to 35 du/ac.
- Revise the High Density Residential (HDR) designation to allow up to 35 du/ac.

Land Use Mix

The proposed land use mix of Alternative C: City Hybrid, is shown in Table 10 and Figure 8.

Table 10: Alternative C Land Use Mix

Designation	Acres	Percent
Residential	4,185	29.5%
Lower-Density Residential (LWDR-4)	478	3.4%
Low-Density Residential (LDR-5)	2,084	14.7%
Low-Medium Density Residential (LMDR-8)	515	3.6%
Medium Density Residential (MDR-12)	543	3.8%
High Density Residential (HDR-35)	565	4.0%
Mixed Use	484	3.4%
Main Street Mixed Use (MMU)	88	0.6%
Broadway Mixed Use (BMU)	385	2.7%
Central District (CD)	11	0.1%
Commercial	634	4.4%
Community Commercial (CC)	356	2.5%
Commercial/Professional Office (CPO)	207	1.5%
Freeway Service (FS)	34	0.2%
Neighborhood Commercial (NC)	26	0.2%
Industrial/Airport	4,059	28.6%
Light Industrial (LI)	1,474	10.4%
General Industrial (GI)	409	2.9%
Heavy Commercial/Manufacturing (HCM)	699	4.9%
Airport Service (AS)	1,477	10.4%
Public and Open Space	3,904	27.5%
Primary Agricultural Open Space (AOS-1)	66	0.5%
Secondary Agricultural Open Space (AOS-2)	929	6.6%
Conservation Open Space (COS)	50	0.4%
Recreation Open Space (ROS)	1,638	11.6%
Community Facilities (CF)	1,221	8.6%

Planned Development	197	6.5%
Downtown Specific Plan (DSP)	197	1.4%
Planned Annexation Area (PAA)	724	5.1%
Total	13,455	100%
Note: Numbers may not add due to rounding.		

Figure 8: Alternative C Land Use Mix

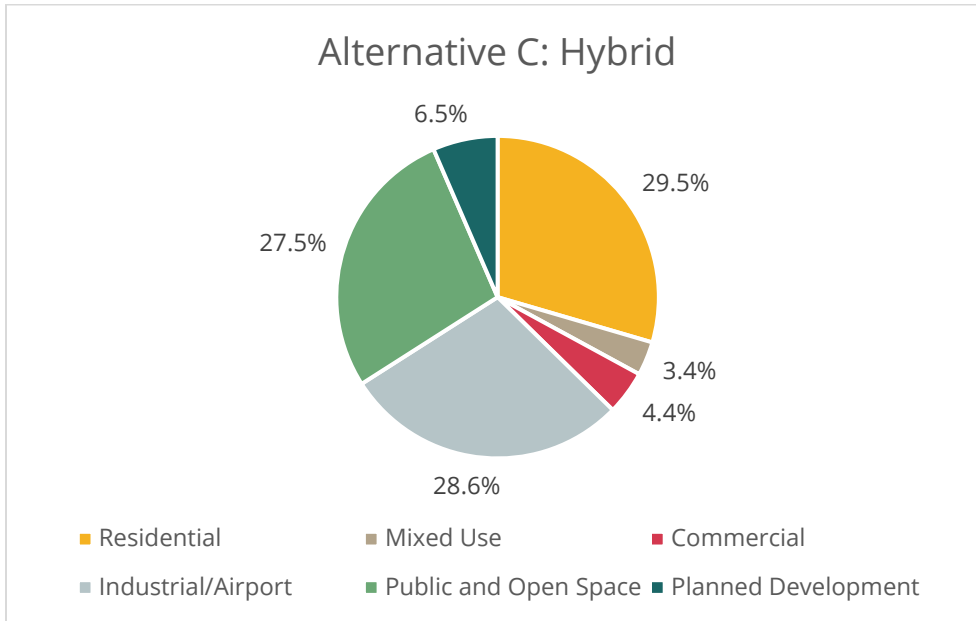

Land Use Map

Figure 9 shows the distribution of land uses for Alternative C: Hybrid throughout the city.

Figure 9: Alternative C Land Use

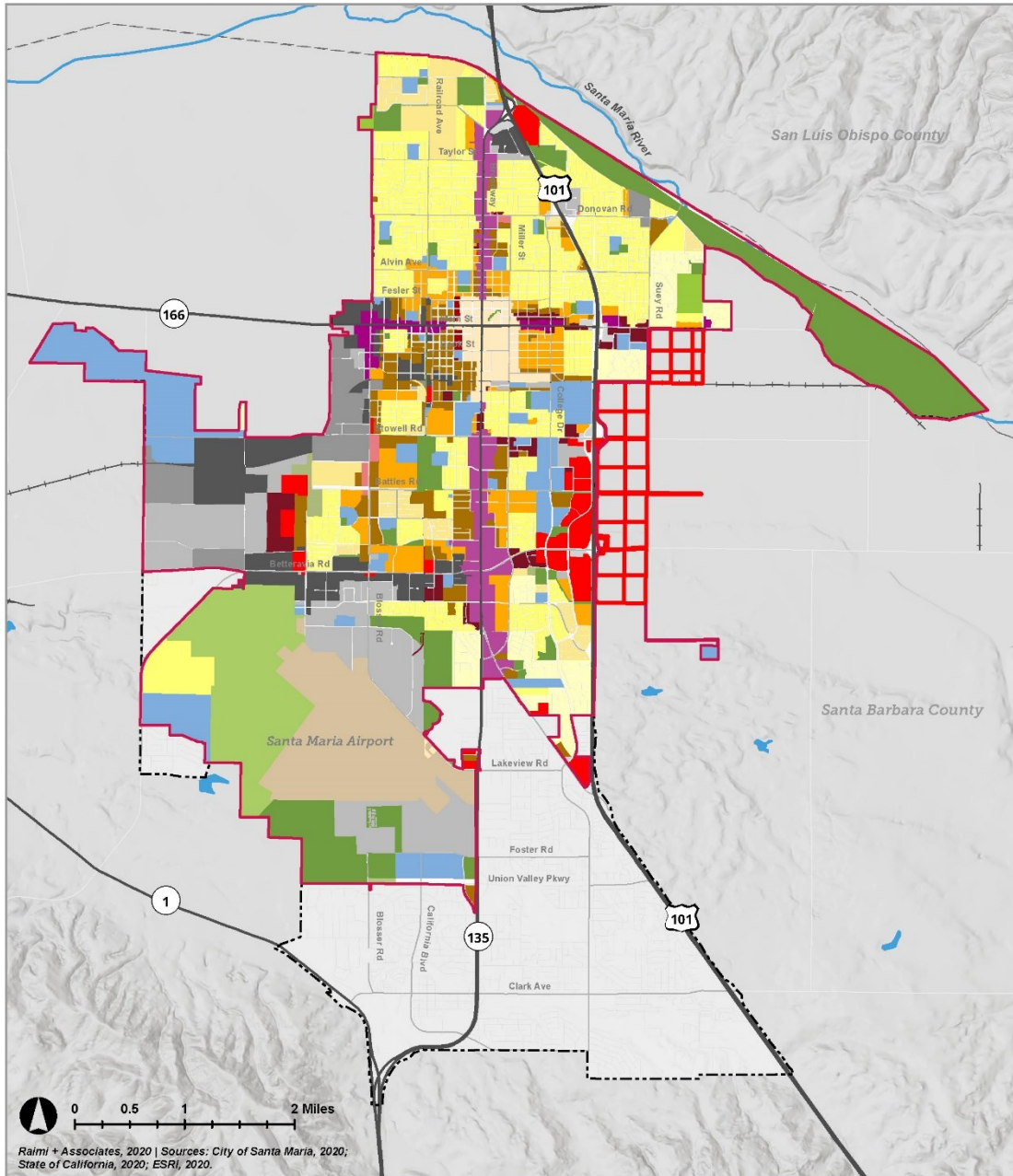

- | Proposed Land Use | | | | | |
|-------------------|---|--|---|--|--------------------------------------|
| | Primary Agricultural Open Space (AOS-1) | | Low Medium Density Residential (LMDR-8) | | Neighborhood Commercial (NC) |
| | Secondary Agricultural Open Space (AOS-2) | | Low Density Residential (LDR-5) | | General Industrial (GI) |
| | Conservation Open Space (COS) | | Lower-Density Residential (LWDR-4) | | Heavy Commercial/Manufacturing (HCM) |
| | Recreational Open Space (ROS) | | Community Commercial (CC) | | Light Industrial (LI) |
| | Community Facilities (CF) | | Broadway Mixed Use (BMU-35) | | Freeway Services (FS) |
| | High Density Residential (HDR-35) | | Main Street Mixed Use (MMU-35) | | Airport Services (AS) |
| | Medium Density Residential (MDR-12) | | Central District (CD) | | Specific Plan (SP) |
| | | | Commercial/Professional Office (CPO) | | Planned Annexation (PA) |

Growth Projections

This section summarizes growth projections of the three Alternatives. Per the “Total Growth to Plan For” section of this report, the Alternatives need to plan for at least 9,300 housing units on vacant and opportunity sites or in potential areas of annexation. The Alternatives do not need to accommodate a minimum number of jobs because pipeline and Specific Plan projects already plan for at least 8,500 jobs across a variety of job sectors.

As shown in the Table 11, all three Alternatives achieve the minimum desired dwelling unit totals. In Alternative A, about 70% of new dwelling units and 50% of new jobs developed in vacant and opportunity areas would be developed outside of City limits, while in Alternative C only about 40% of dwelling units and 20% of jobs would be developed outside of City limits. Alternative B has the lowest amount of job growth of the three Alternatives because vacant land and opportunity sites in the city were prioritized for housing development.

Table 11: Projected New Dwelling Unit and Job Growth

	Target	Alternative A: Annexation	Alternative B: City Infill	Alternative C: Hybrid
Dwelling Units				
New growth projected ¹	9,300	9,770	10,010	9,690
<i>Within City limits</i>	-	3,020 (31%)	10,010 (100%)	5,810 (60%)
<i>Outside City limits</i>	-	6,750 (69%)	-	3,880 (40%)
Jobs				
New growth projected ¹	-	14,580	8,720	15,830
<i>Within City limits</i>	-	7,790 (53%)	8,720 (100%)	13,010 (82%)
<i>Outside City limits</i>	-	6,790 (47%)	-	2,820 (18%)
Notes:				
1. Growth totals for each Alternative do not include projected growth from pipeline projects, ADUs/JADUs, and Specific Plans, with the exception of the Area 9 Specific Plan in Alternative B and C, which assume the Area 9 Specific Plan will be revised to allow residential use and additional commercial uses.				
2. Data source: Urban Footprint				

Table 12 summarizes total population, dwelling units, and job totals of the three Alternatives by the year 2050. Even with annexation in Alternatives A and C, the vast majority of total population, dwelling units, and jobs would still be located within existing City limits.

Table 12: Projected Total Population, Dwelling Units, and Jobs

	Base (2022) ¹	Alternative A: Annexation	Alternative B: City Infill	Alternative C: Hybrid
Population				
Total population	108,600	142,680	144,420	141,480
<i>Within City limits</i>	108,600	126,920 (89%)	144,420 (100%)	132,500 (94%)
<i>Outside City limits</i>	-	15,760 (11%)	-	8,980 (6%)
Dwelling Units				
Total	28,200	44,420	45,660	44,340
<i>Within City limits</i>	28,200	37,670 (85%)	45,660 (100%)	40,460 (91%)
<i>Outside City limits</i>		6,750 (15%)	-	3,880 (9%)
Jobs				
Total	43,050	65,540	59,680	66,800
<i>Within City limits</i>		58,750 (90%)	59,680 (100%)	63,980 (96%)
<i>Outside City limits</i>		6,790 (10%)	-	2,820 (4%)
Notes:				
1. Source: Urban Footprint				

Mobility Alternatives

This section highlights key findings from the attached Mobility Alternatives Technical Memorandum (see Appendix A). That memorandum describes the existing circulation system and how existing facilities can inform improvements associated with each of the three land use Alternatives. The memorandum also evaluates mobility improvements for the three Alternatives, such as closing gaps in multimodal networks for transit, pedestrian, and bicycle, regional traffic needs, and recommended polices.

Multimodal Traffic Assessment

Each of the three land use Alternatives were evaluated to understand the existing multimodal facilities and future needs.

All Alternatives would need further infrastructure, including the Broadway and Main Street corridors as transit priority corridors with exclusive red bus lanes, proposed pedestrian and bicycle improvements as identified in the adopted Active Transportation Plan (ATP), operational improvements at intersections, and capacity improvements on the eastern end of Betteravia Road, western end of Main Street and Betteravia Road, and northern end of US 101 in Santa Maria.

In general, Alternative A (Annexation) would need more infrastructure due to the lack of existing transportation facilities for vehicles, bicycles, and pedestrians. In addition, no transit services are provided in the areas that are not in the current city limits. However, after annexation, there will be opportunities to provide the proper infrastructure with the new construction and development.

Transit

In Alternative A (Annexation) and Alternative C (Hybrid), transit services would need to be added to the annexed parcels. For Alternative B (Infill), most of the parcels are already being serviced by transit. Regardless of which Alternative is selected as the preferred Alternative, transit and alternative transit mobility options would continue to be enhanced due to anticipated population and job growth.

Pedestrian and Bicycle Facilities

There are several proposed bikeways, pedestrian facilities, and enhanced crossings from the ATP within City limits, but there are no improvements identified in the proposed areas of annexation in Alternatives A and C. If either of those land use Alternatives are slated to move forward, further evaluation of the bicycle and pedestrian network (and recommended accommodations) will need to be performed.

Since Main Street and Broadway are under the jurisdiction of Caltrans, there are limited proposed improvements along these corridors. More improvements are suggested on lower speed and volume roadways. These roadways provide a better level of comfort but are not always the most convenient.

Vehicular Traffic Assessment

Level of Service (LOS) at Select Locations

When comparing the LOS between the three land use Alternatives for roadway segments with existing volumes, both the Annexation and Infill scenarios are similar. However, the Annexation scenario has better LOS for four more segments than Infill. For the locations with failing LOS, multimodal and emerging technology strategies can be analyzed to reduce the vehicular impact on the roadways. Overall, Alternative A (Annexation) will have the least impact on existing roadways but will require new roadways with the land use change from agriculture to higher density land uses (residential, commercial, etc.).

Vehicle to Capacity Ratio

Vehicle to Capacity Ratios (V/C Ratios) are a measure of effectiveness (MOE) in assessing vehicle congestion and delay. When a V/C ratio is 0.91 or higher, there will be unfavorable congestion and delay (level of service E or worse) with it failing once is greater than V/C ratio of 1 (amount of vehicles exceeds roadway capacity).

V/C ratios were used to compare the different land use Alternatives. Using the City's traffic demand model, the current roadways in Santa Maria were compared. In general, the V/C Ratio is adequate at most city roadways with exceptions along US 101, SR 135, Main Street (SR 166), and Betteravia Road. Out of the different land use Alternatives, Alternative A (Annex) has the best V/C Ratio along the western end of Betteravia Road and Alternative B (Infill) has the best V/C Ratio along the western end of Main Street (SR 166) and the majority of US 101 in the city.

Vehicle Miles Traveled

Vehicle Miles Traveled (VMT) was assessed for all land use Alternatives. Per the results of this analysis, Alternative B (Infill) has the best VMT of the three Alternatives per capita and household (HH), particularly if transit and active transportation options within the city are improved upon. Alternative C

(Hybrid) was developed by using the worst case of Alternative A (Annexation) and Alternative B (Infill). Therefore, the VMT for this Alternative was the highest per capita and household.

However, in selecting a preferred land use Alternative it is important to compare the overall increase of VMT to the base. With the proposed three land uses having an imbalance between jobs and housing, there is a significant increase in VMT with every Alternative in comparison to the base scenario. It is recommended in the preferred Alternatives that the land use follow the current Sustainable Communities Strategy (SBCAG 2050 RTP) that only allows jobs or housing in the future if they can be balanced.

The low VMT generating scenario, such as Alternative B (Infill) generates more volumes in high-speed bins (speeds between 40 and 60 miles per hour). High VMT generating scenarios such as Alternative A (Annexation) and Alternative C (Hybrid) generate more volumes in low-speed bins.

Recommendations

The traffic needs from the base model and future (2050 SBCAG’s Regional Transportation Plan forecast) scenarios show that US 101 north of Santa Maria would benefit from widening. US 101 through the City of Santa Maria widens to three lanes in each direction but drops back down to two lanes in each direction around the San Luis Obispo County line. With the current push to reduce greenhouse gas emissions (GHGs), it is unlikely a widening project will occur so it will be important to identify alternative modes such as Bus Rapid Transit, commuter rail, or ride sharing services.

Transportation Policy Recommendations

There were no distinguishable traffic differentiators to the three land use Alternatives in relation to the congestion on the roadways. Therefore, it is recommended that the City implement various transportation policies that guide and lead the transportation infrastructure and complement the various recommendations from the City’s existing plans.

Road Diets

Recommendation: Implement a road diet policy to reallocate space for alternative transportation modes

Road diets can reallocate travel lanes to space for alternative modes of transportation (bicycle lanes, transit lanes, and bus turnouts). Most common applications include converting a four-lane roadway to a three-lane roadway with a two-way left turn lane (TWLTL). Figure 10 shows a road diet with adjacent parallel parking.

Figure 10: Cross Section of a Road Diet Concept

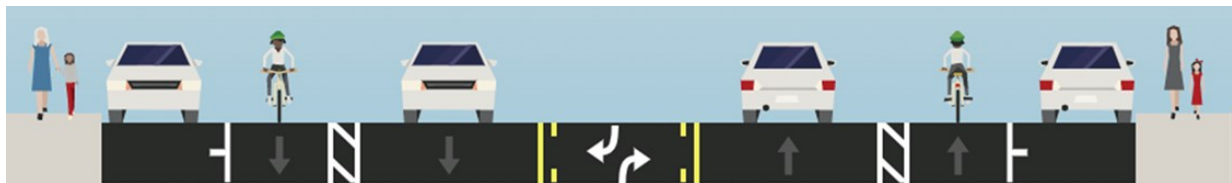

Road diets can also improve safety by reducing the vehicle conflict points for left-turning movements at intersections and driveways. On a four-lane divided road, left-turning traffic from the major street must

store in the through lane before making the turn. In addition, vehicles turning left out of the minor street or driveway will have to cross additional lanes and have more conflict points. A road diet can reduce the travel lanes a vehicle must cross and provide a painted median storage (TWLTL) for a vehicle to make a two-stage crossing.

The Federal Highway Administration (FHWA) advises that roadways with ADT of 20,000 vehicles per day (vpd) or less may be good candidates for a road diet and should be evaluated for feasibility. With a road diet, it is important to evaluate the intersections along the corridor, as well as the segments, as they can act as the bottlenecks. Therefore, road diets should consider additional intersection operational improvements.

Level of Service Analysis at Select Roadway Segments

Several roadway segments were identified in the Existing Conditions report for potential road diets, including segments of Alvin Avenue, A Street, Battles Road, Black Road, Blosser Road, Bradley Road, College Drive, Cook Street, Depot Street, Donovan Road, E Street, Fesler Street, Mahoney Road, McCoy Lane, Main Street, Miller Street, Panther Drive, Santa Maria Way, Stowell Road, Suey Road, and Union Valley Parkway. The LOS was determined using existing and forecasted ADT volumes. The resulting LOS for each of the Alternatives are shown in Appendix A of the Technical Memorandum. For all but seven locations, the LOS was A for the existing and Alternative scenarios, keeping lane geometry the same.

The locations classified as four-lane, secondary arterials were further analyzed to evaluate the difference in LOS if the number of lanes reduced to two. The results from this analysis are displayed in Appendix A. Out of the 30 locations analyzed, 8 locations have a failing LOS after reducing the number of lanes in future scenarios. Those locations that fail in 2050 should be evaluated during the growth of the city as currently the traffic volumes support a road diet.

Changes to Typical Sections

Recommendation: Encourage a mode shift due to the increased impact of vehicles in the future scenarios. One strategy to reduce the vehicular impact on the roadways is installing increased multimodal infrastructure.

Currently, the City’s Standard Drawings for typical sections are provided by land use, including residential, commercial, and industrial. These standard drawings are similar in nature and have limited accommodations for alternate modes of travel, especially bicycles (see Figures 11, 12, 15 and 16 below). Existing residential and commercial typical sections are identical, except for sidewalk and ROW width. Proposed alternative typical sections are proposed for commercial and residential land uses to provide a better level of traffic stress for bicycles. Some proposed changes to accommodate these alternate modes are displayed in Figures 13, 14, and 17. These typical sections show what can be done to repurpose the outside lanes for bikeways. With many of the city roadways varying in width, it will be important to evaluate each roadway on a case-by-case basis with the traffic volumes and current cross sections.

Figure 11: Existing Typical Section for Secondary Arterial (Residential Street)

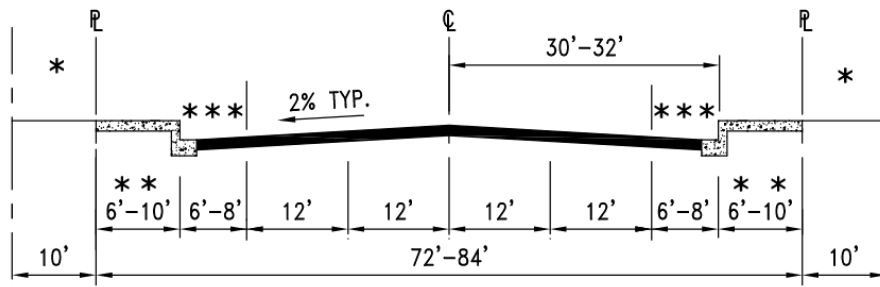

Figure 12: Existing Typical Section for Secondary Arterial (Commercial Street)

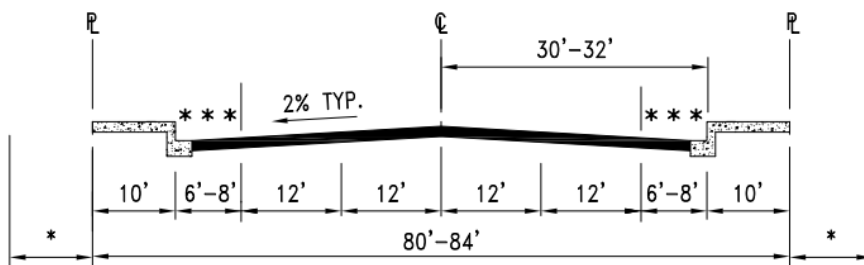

Figure 13: Proposed Typical Section for Secondary Arterial (Parking-Protected Bike Lanes)

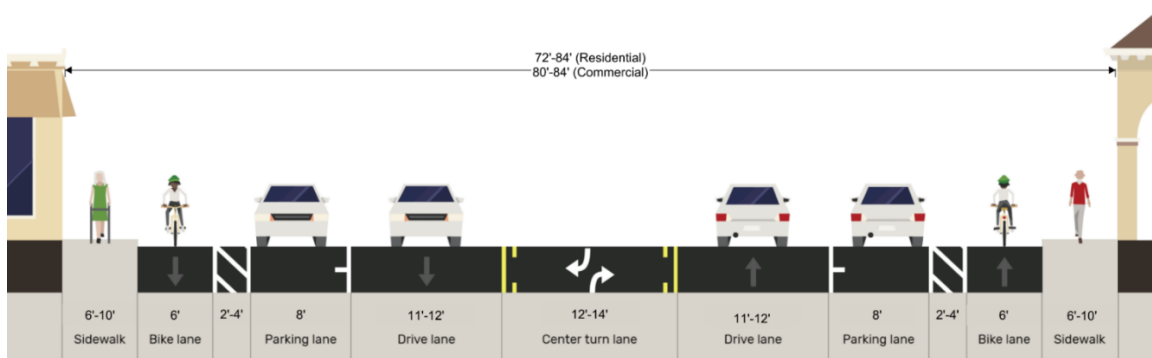

Figure 14: Proposed Typical Section for Secondary Arterial (Buffered Bike Lanes and Parking)

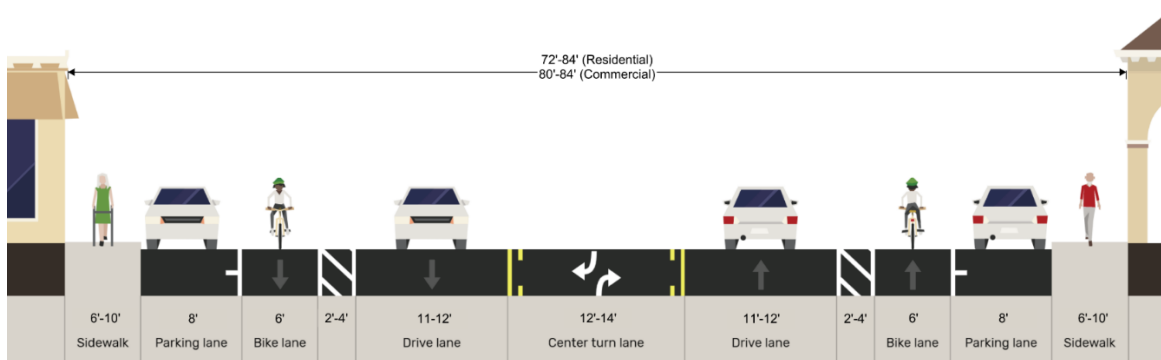

Figure 15: Existing Typical Section for Primary Arterial (Residential Street)

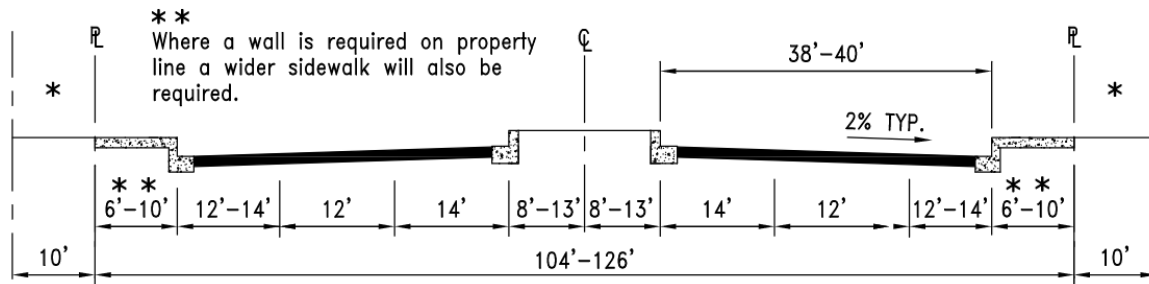

Figure 16: Existing Typical Section for Primary Arterial (Commercial Street)

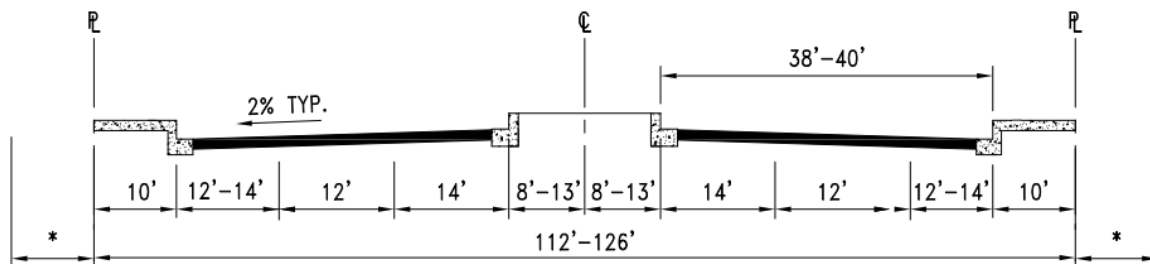
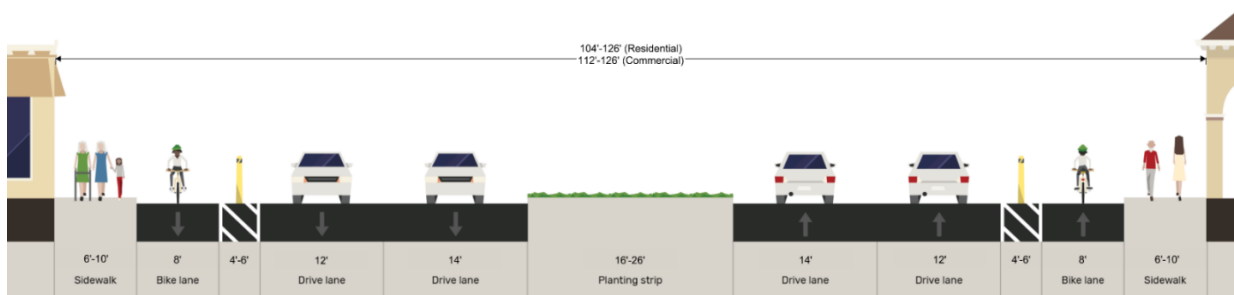

Figure 17: Proposed Typical Section for Primary Arterial (Bicycle Lane with Raised Buffer)



Emerging Technologies

Recommendation: Support and implement projects with emerging technologies for improved multimodal operations.

Emerging technologies can include converting the existing traffic signals with inductive loop detection to video detection for bicycle detection. In addition, with new controllers at the signalized locations, leading pedestrian intervals can be implemented in giving the pedestrians 5 seconds of time before the vehicles, to establish their right of way in the crosswalks.

Transit Priority Routes

Recommendation: Incorporate transit priority routes

Prioritizing alternative modes can reduce vehicle congestion and greenhouse gases in high-density land use areas that support transit priority routes such as Broadway. Figure 18 below shows an example of a typical section for a primary arterial that dedicates a travel lane to buses (red bus lane). This typical section will be especially important along the Broadway corridor in the Infill Alternatives where there is proposed much high land use densities and a major bus route.

Figure 18: Proposed Typical Section for Primary Arterial (Transit Only Lane)

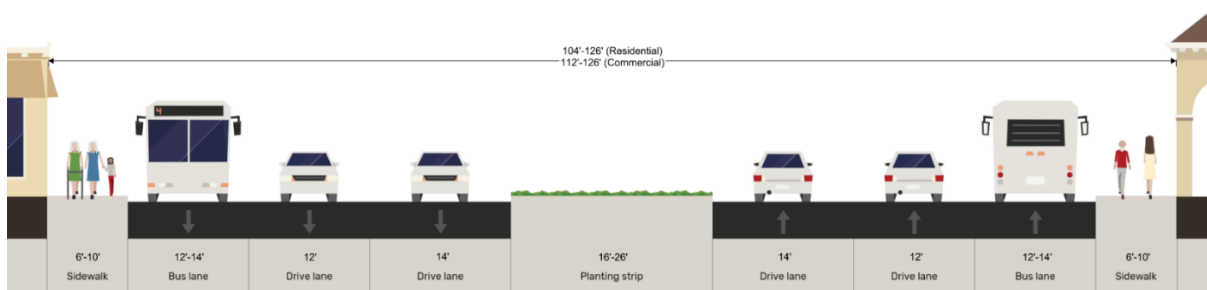

Conclusion

The memorandum's key findings are summarized in matrix format in Table 13. Per the traffic model, with the anticipated growth in 2050 for any land use scenario, many roadways will reach or exceed capacity thresholds. Therefore, it is very important to provide alternative modes of transportation as a priority, which shifts vehicle traffic to transit, biking, or walkable trips. Therefore, a variety of mobility improvements are needed citywide regardless of future development patterns, including congestion mitigation on major roadways, implementation of the ATP, incorporation of new roadway sections and road diets, and planning for emerging technologies.

The Preferred Alternative should be designed to mitigate VMT impacts. If the Preferred Alternative involves annexation, the expansion of roadway, ATP, and transit networks will need to accompany annexation.

From the level-of-service analysis, several roadways in Santa Maria have opportunities for road diets based on the existing and forecasted future volumes. A road diet can allow bikeways to be added with minimal cost and provide connectivity in the transportation system. With the suggested new typical sections for the secondary arterial, evaluation of the current road cross section would need to be further assessed to see what could feasibly be accommodated. These roadways could still function as a secondary arterial versus a collector roadway but can have the additional lanes repurposed for alternative modes.

Table 13: Mobility Alternatives Comparison

Mobility Factor	Mobility Improvements for All Land Use Alternatives	Mobility Alternatives		
		Alternative A: Annexation	Alternative B: Infill	Alternative C: Hybrid
Vehicular Network		Requires new roadways		Requires new roadways
LOS & Congestion	Congestion mitigation required on SR 135, Main Street (SR 166), and Betteravia		LOS mitigation required	
VMT	Jobs-housing balance, alternative commute modes, and CEQA VMT Threshold compliance	VMT mitigation required		VMT mitigation required
Active Transportation Network	Implement ATP	Network expansion required		Network expansion required
Road Sections and Diets	Update roadway sections; Implement road diet policy			
Transit System		New services required		New services required
Emerging Technologies	Adopt appropriate technologies			

Public Realm Alternatives

This section includes highlights from the Public Realm Design Options slide deck (see Appendix B). The updated General Plan will include design guidance to preserve community character, including how public realm and urban design tools are to be applied citywide and by subarea or neighborhood. The Public Realm Design Options can serve as the basis for the design guidance in the General Plan.

The slide deck introduces 16 tools for enhancing the public realm and urban design for both open spaces and streets in Santa Maria. For each tool, the slide deck describes the intent, applicability in Santa Maria, and which land use designations it is intended for. The slide deck also geographically illustrates where particular tools would apply in key areas of change, unique to each land use Alternative, and how tools can be applied on primary and secondary arterials.

Street Sections

The sections below in Figures 19 and 20 illustrate how toolkit items can be applied on primary and secondary arterials, like Broadway and Main Street respectively. These sections are identical to those proposed in the Mobility Alternatives section (see Figures 13, 14, and 17) but enhanced to show possibilities for public realm design.

Figure 19: Primary Arterial

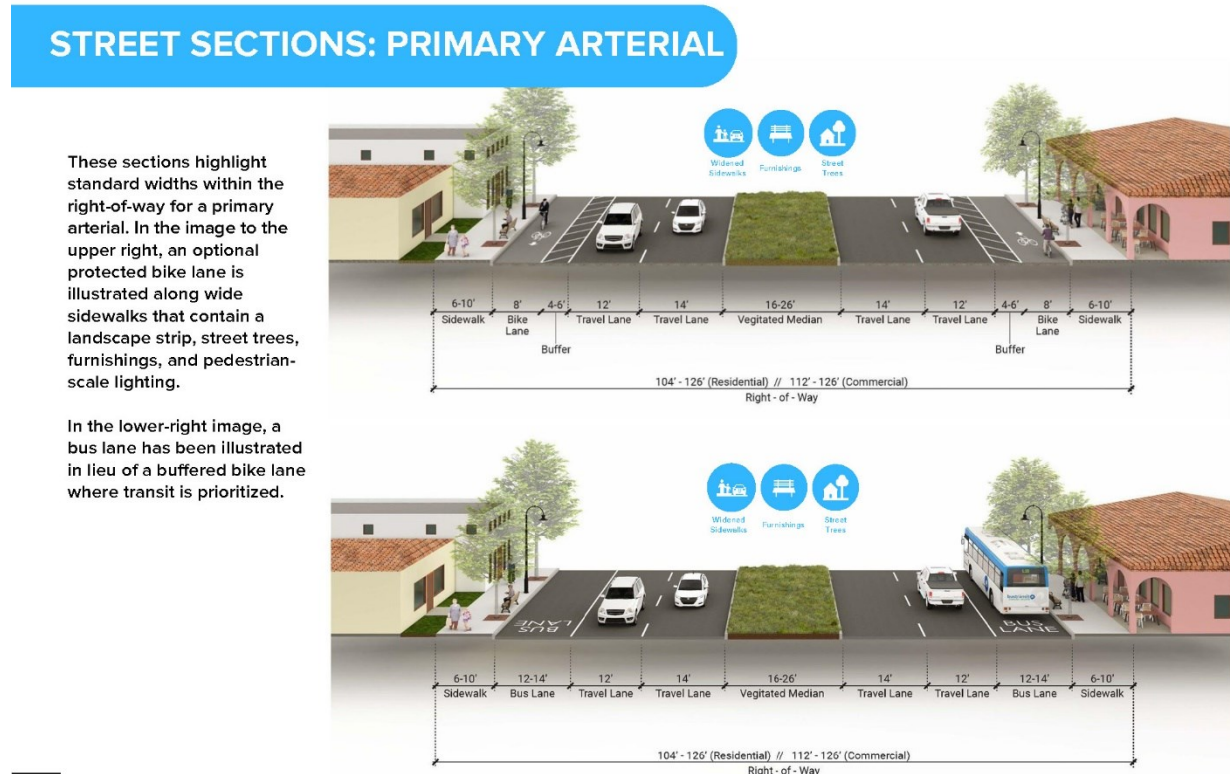
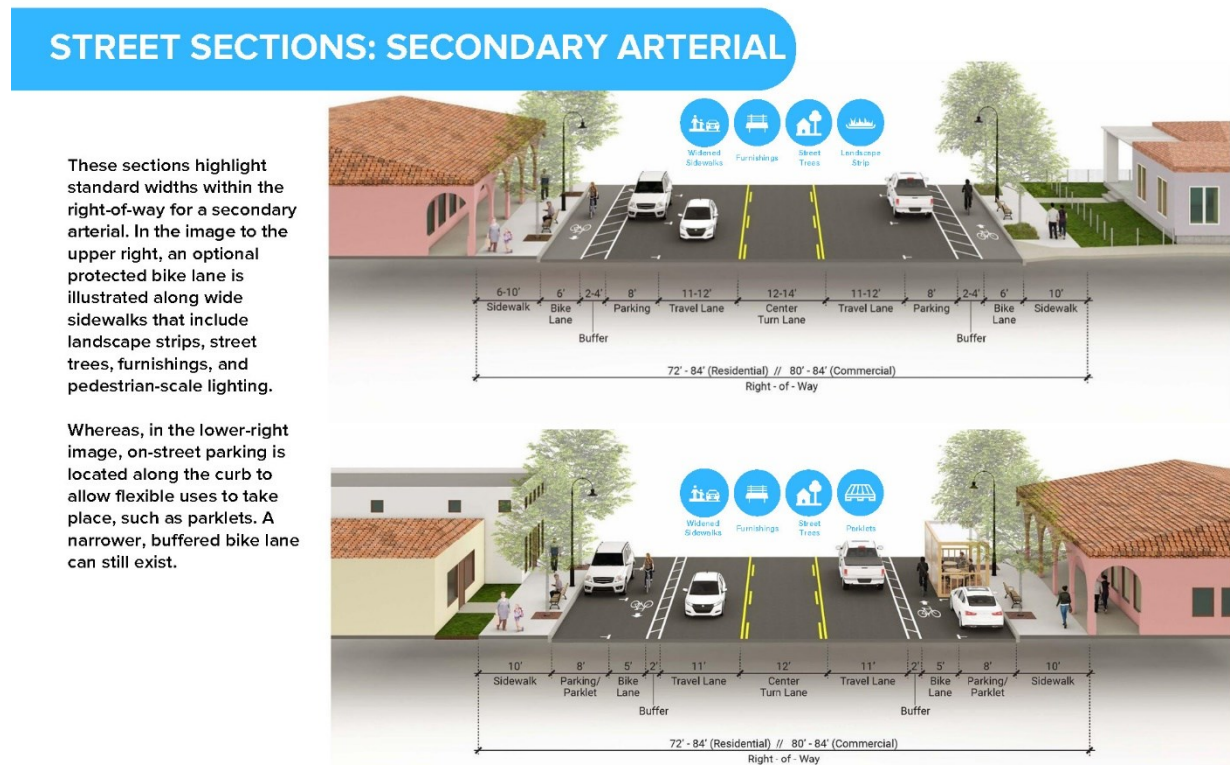

Figure 20: Secondary Arterial



Relationship to Land Use Alternatives

The matrix below (Figure 21) matches toolkit items with General Plan land use designations, which regulate land use, density, and intensity. When considering potential future land use Alternatives, the matrix can be used to identify how different public realm and urban design tools could be applied in different parts of the city. Note, some toolkit items may be recommended in the General Plan regardless of the land use Alternative. Community engagement is needed to confirm if these tools are appropriate for Santa Maria in the locations proposed.

Figure 21: Toolkit

	Primary Agricultural Open Space (AOS-I)	Secondary Agricultural Open Space (AOS-II)	Conservation Open Space (COS)	Recreation Open Space (ROS)	Community Facilities (CF)	High Density Residential (HDR-35/30)	Medium Density Residential (MDR-12)	Low Medium Density Residential (LMDR-8)	Low Density Residential (LDR-5)	Lower-Density Residential (LWDR-4)	Community Commercial (CC)	Broneway Mixed Use (BMCU-70/35)	Main Street Mixed Use (MMLC-70/35)	Central District (CD)	Specific Plan (SP)	Commercial/Professional Office (CPO)	Neighborhood Commercial (NC)	General Industrial (GI)	Freeway Service (FS)	Heavy Commercial/Manufacturing (HCM)	Light Industrial (LI)	Airport - Airport Services (AAS)	Planned Annexation (PA)	
OPEN SPACES	Natural Open Space			X																				X
	Park	X	X	X	X	X	X	X	X	X	X	X	X	X	X			X				X		X
	Piazza					X	X	X				X	X	X	X									X
	Trell	X	X	X	X	X	X	X	X	X	X		X	X	X	X	X	X	X	X	X	X	X	X
	Pocket Park						X	X				X	X	X	X	X								
	Food Truck Pod				X		X	X				X	X	X	X	X	X					X		
STREETS	Sidewalk Widening				X	X	X					X	X	X	X		X							
	Street Trees			X	X	X	X	X	X	X	X	X	X	X	X	X	X							X
	Furnishings			X		X	X				X	X	X	X	X	X	X							
	Landscape Strip					X	X				X	X	X	X	X		X							X
	Curb Extension					X	X				X	X	X	X	X		X							X
	Alleyway Activation										X	X	X	X	X									
	Slow Street					X	X	X	X	X														
	Parklets										X	X	X	X	X		X							
	Getaways										X	X	X	X	X									X
	Public Art					X	X				X	X	X	X	X	X	X	X						X

Areas of Change

The maps below show key areas of change for each land use Alternative. The toolkit items listed next to the maps are open space and street concepts that can apply to land use designations in these change areas. This comparison shows how public realm applications vary between the three land use Alternatives.

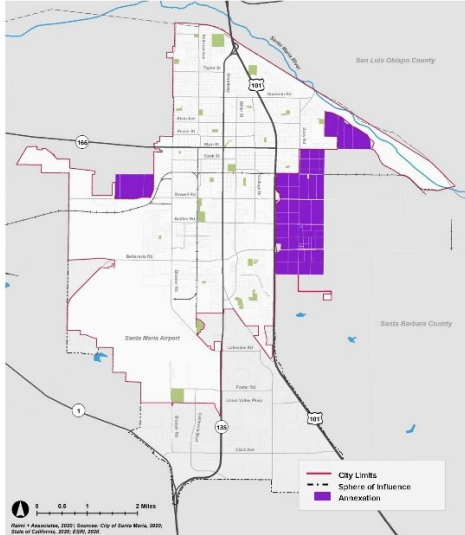

Alternative A: Annexation

Open Space Toolkit Items: Natural Open Space, Parks, Plazas, Trails

Street Toolkit Items: Street Trees, Landscape Strip, Curb Extensions, Gateways, Public Art

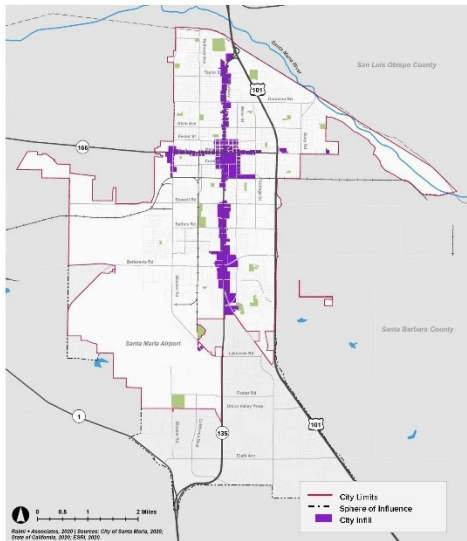

Alternative B: City Infill

Open Space Toolkit Items: Parks, Food Truck Pods, Trails, Pocket Parks, Plazas

Street Toolkit Items: Slow Streets, Alleyway Activation Sidewalk Widening, Landscape Strips, Curb Extensions, Parklets, Street Trees, Furnishings, Gateways, Public Art

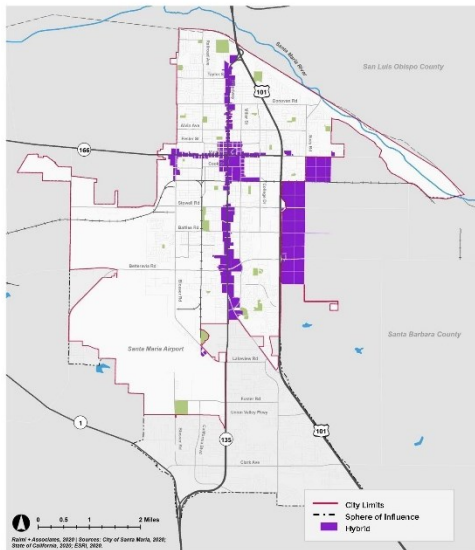

Alternative C: Hybrid

Open Space Toolkit Items: Open Space, Parks, Food Truck Pods, Trails, Pocket Parks, Plazas

Street Toolkit Items: Slow Streets, Alleyway Activation, Sidewalk Widening, Landscape Strips, Curb Extensions, Parklets, Street Trees, Furnishings, Gateways, Public Art

Appendix A: Mobility Alternatives Memorandum



Technical Memorandum

September 13, 2022

To	Ron Whitmore, PhD, AICP Meghan McNulty, AICP	Project No.	11208620
Copy to	Don Hubbard, TE, AICP Billy Park, TE		
From	Kathryn Kleinschmidt, PE, PTOE Emily Darke, EIT		
Project Name	Santa Maria General Plan Update		
Subject	Subtask 4.4 – Prepare Land Use, Transportation, and Policy Alternatives		

1. Introduction

This technical memorandum will outline the existing circulation system including the multimodal network and how these facilities can inform improvements with the three land use alternatives. Those alternatives are as follows:

1. Alternative A – Annexation (Annex)
2. Alternative B – Infill
3. Alternative C – Hybrid

These alternatives are further described below. This memorandum will include evaluating improvements such as closing gaps in multimodal networks for transit, pedestrian, and bicycle, regional traffic needs, and recommended polices.

1.1 Alternative A (Annex)

Alternative A proposes annexing approximately 1,770 acres to accommodate new housing and employment growth. This alternative distributed new housing and employment throughout the City of Santa Maria with new areas annexed, east of US 101 (south and north of Main Street (SR 166)) and west of US 101 on Stowell Road. The areas identified for annexation are currently agricultural or vacant land uses with limited transportation facilities.

1.2 Alternative B (Infill)

Alternative B is described as city infill with large concentrations of housing and employment (mixed use) along Broadway (SR 135) and Main Street (SR 166). With a concentration of mixed-use land uses, there is more interaction between the different modes of travel such as walking, biking, taking transit, and driving with likely lower vehicle miles of travel. Therefore, this alternative is modeled to capture the mode splits between

This Technical Memorandum is provided as an interim output under our agreement with Raimi + Associates. It is provided to foster discussion in relation to technical matters associated with the project and should not be relied upon in any way.

transportation options and subsequent vehicle trip reductions due to this type of land use which encourages shorter trips which naturally lend to alternative modes such as walking, biking, and taking transit.

1.3 Alternative C (Hybrid)

Alternative C is a hybrid of Alternative A (annexation scenario) and Alternative B (infill scenario). This hybrid alternative distributes new housing and employment within the current city limits and in new areas of annexation, east of US 101 and south of Main Street (SR 166). The area that is identified to be annexed is currently agricultural land uses with limited transportation facilities.

2. Multimodal Traffic Assessment

Each of the three land use alternatives were evaluated to understand the existing multimodal facilities and future needs. In general, Alternative A would need more infrastructure due to the lack of existing transportation facilities for vehicles, bicycles, and pedestrians. In addition, no transit services are provided in the areas that are not in the current city limits. However, after annexation, there will be opportunities to provide the proper infrastructure with the new construction and development. It would be recommended the city have multimodal typical sections for the different classifications of roadways to include local, collector, and arterial roadways.

All alternatives would need further infrastructure, including the Broadway and Main Street corridors as transit priority corridors with exclusive red bus lanes, proposed pedestrian and bicycle improvements as identified in the adopted Active Transportation Plan (ATP), operational improvements at intersections, and capacity improvements on the eastern end of Betteravia Road, western end of Main Street and Betteravia Road, and northern end of US 101 in Santa Maria.

Recently, the city updated the *Short-Range Transit Plan, August 2020* for Santa Maria Area Transit and *2020 Active Transportation Plan*. Recommendations from these plans will be summarized below.

2.1 Transit Operations

The City of Santa Maria's transit service is Santa Maria Regional Transit (SMRT), formerly known as Santa Maria Area Transit (SMAT). There are also a variety of regional transit services with transit stops in the city including Clean Air Express, Guadalupe Flyer, and Route 10 of the San Luis Obispo Regional Transit Authority (RTA) and intercity Breeze bus service to Lompoc (Route 100) and to Buelton/Solvang (Route 200). Clean Air Express offers weekday commuter bus from Northern Santa Barbara County to Goleta and Santa Barbara. Guadalupe Flyer offers transit services between Guadalupe and Santa Maria. Route 10 of RTA serves Santa Maria, Nipomo, Arroyo Grande, Pismo Beach, and San Luis Obispo. These services could be expanded with improved performance in capturing the demand of commuters.

2.1.1 Short Range Transit Plan

2.1.1.1 Service Recommendations

The Short Range Transit Plan had several service recommendations for Santa Maria's transit that include performance improvements, service enhancements, policy recommendations, and innovative/technology recommendations. These service recommendations are summarized below.

Performance Improvements

- **Improve local service on-time performance**
- **Increase transit staffing by 1 FTE**
- Develop and implement 18- to 24-month Marketing Plan

- Expand SMAT’s social media presence
- Refine Breeze schedule to better match capacity with demand
- Reconfigure Route 8 to provide service to Walmart
- Formalize or discontinue interlining of Routes 3 and 4
- Consider revising the city’s service delivery approach to include geographic-based neighborhood shuttles in lieu of low-productivity fixed-route service
- Limit evening service on Routes 5 and 6 to the Broadway corridor
- Consider replacing evening service with Lyft/Uber subsidized rides.

Service Enhancements

- Increase school tripper capacity
- Consider assumption of the Guadalupe Transit service
- Ensure a proportional payment for SLORTA Route 10 operations
- Increase peak-hour service
- Adjust service to incorporate the proposed Allan Hancock College transit hub

Policy Recommendations

- Update and expand the city’s Bus Stop Improvement Plan
- Develop a Bus Stop Placement Policy

Innovation/Technology Recommendations

- Evaluate cost-benefit of mobile fare payment options
- Secure funding to AVL technology
- Introduce predictive arrival technology
- Define path for transition to battery-electric fleet

2.1.1.2 Ridership and Access

The ridership throughout the city, along with local routes and stops, is captured in **Figure 1**. This information is from Santa Maria Area Transit (SMAT), which is currently known as Santa Maria Regional Transit (SMRT).

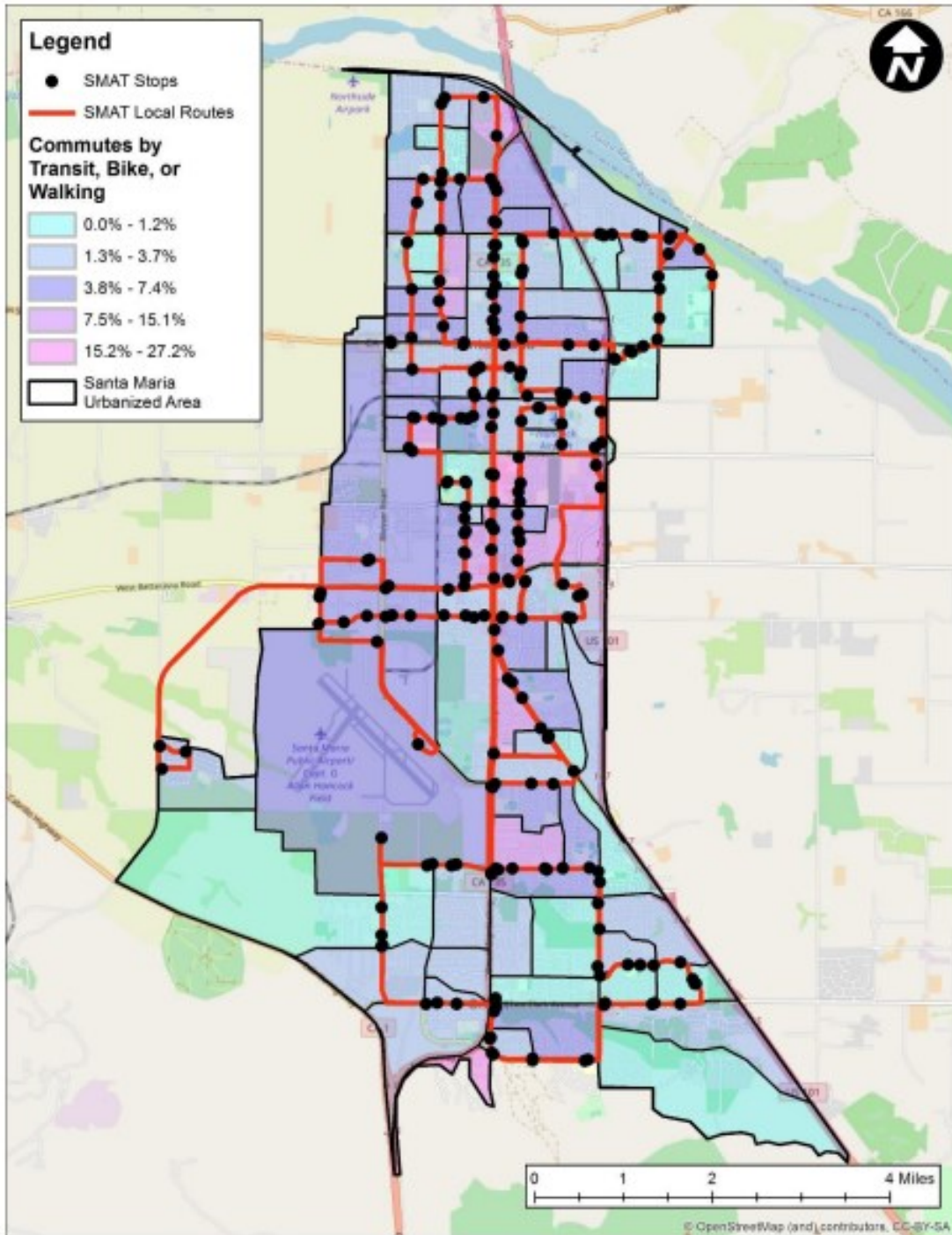

Source: Means of Transportation to Work 2011-2016 American Community Survey 5-Year Estimates

Figure 1 SMAT Local Routes and Stops with Ridership Percentages

Figure 2 displays the local routes with quarter mile and half-mile radii. There is a gap in southern central area of the city, north of E Clark Avenue.

Exhibit 3.14 Local Transit – SMAT Quarter-Mile Buffer

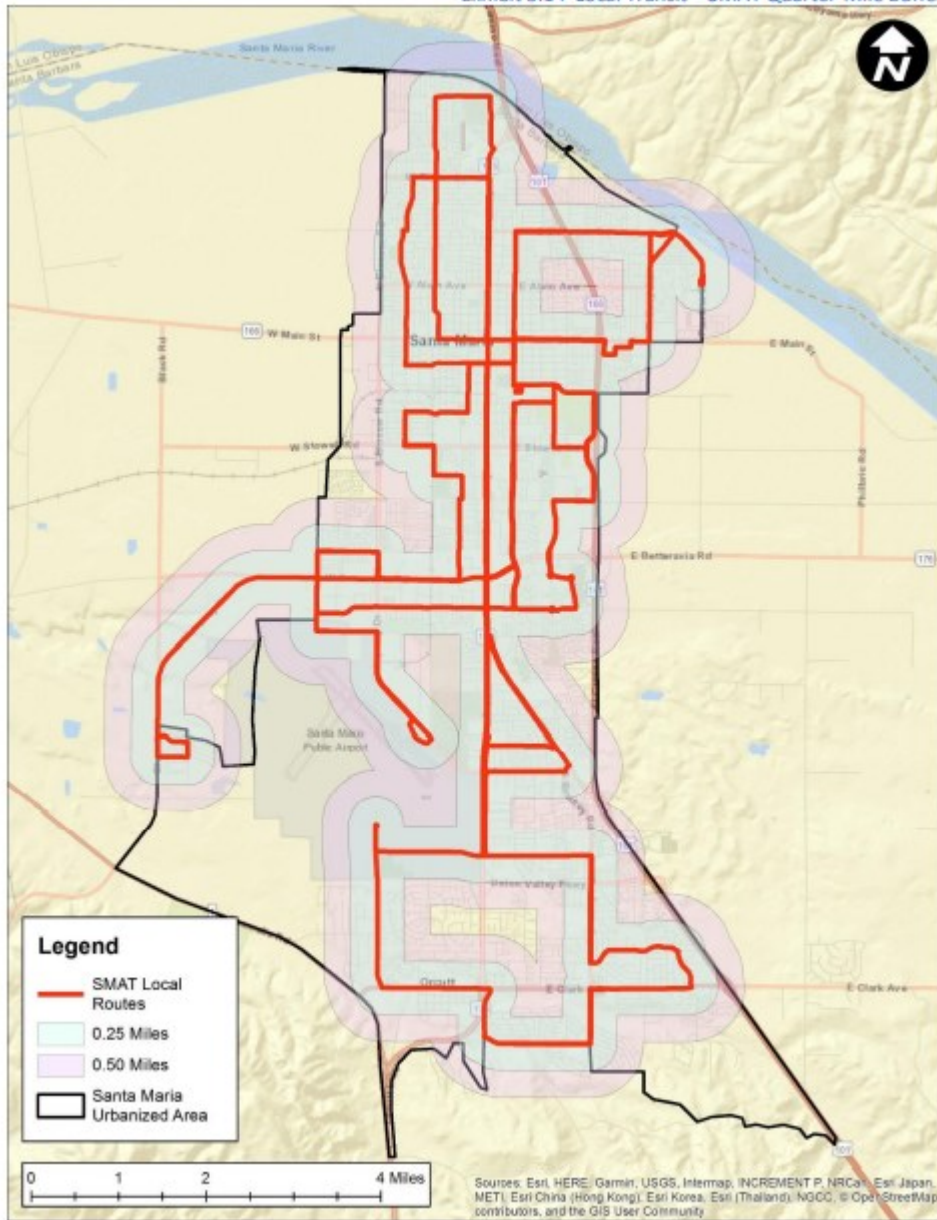
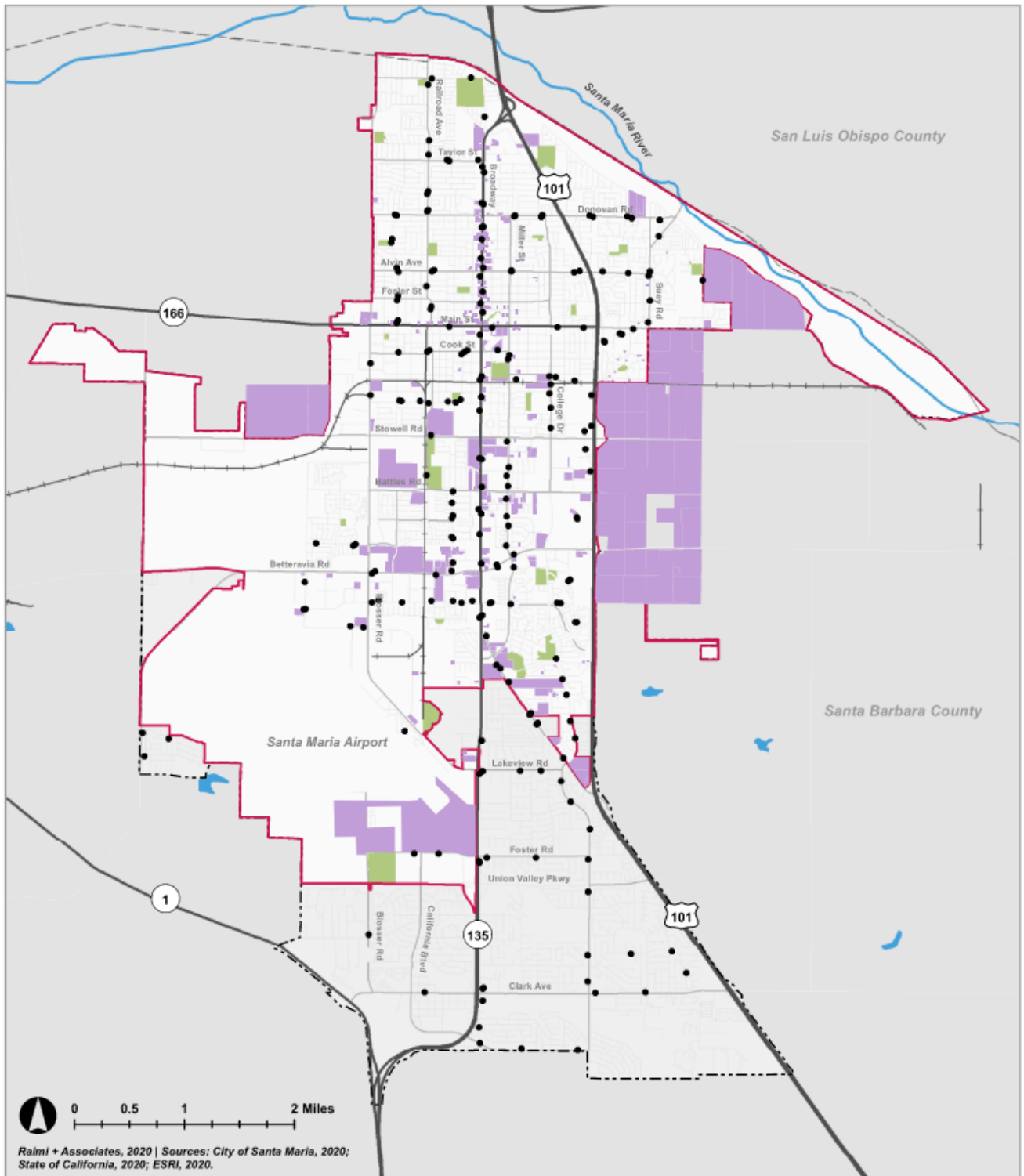

Figure 2 SMAT Quarter Mile Buffer

2.1.2 Land Use Alternatives

The transit stops within the city are displayed below, along with the different land use alternatives (see **Figures 3, 4, and 5**). In Alternative A (Annex) and Alternative C (Hybrid), transit services would need to be added to the annexed parcels. For Alternative B (Infill), most of the parcels are already being serviced by transit.



Raimi + Associates, 2020 | Sources: City of Santa Maria, 2020; State of California, 2020; ESRI, 2020.



- Modified Parcel (Annex Alternative)
- Parks
- Santa Maria City Limits
- Sphere of Influence
- Water
- County Boundaries
- Transit Stop
- Railroads

Figure 3 Transit Stops and Alternative A (Annex)

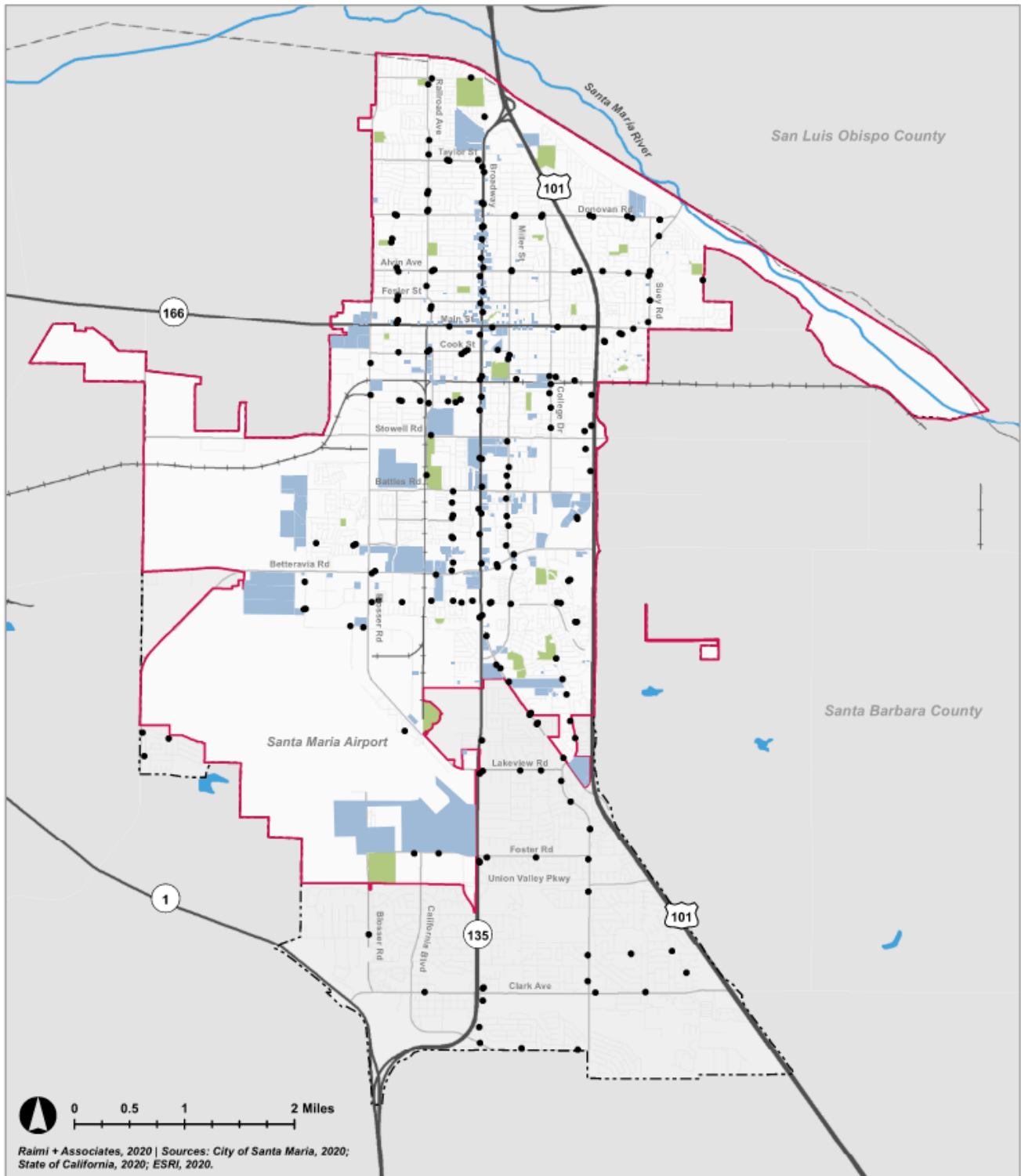

- Modified Parcel (Infill Alternative)
- Santa Maria City Limits
- Parks
- Transit Stop
- Sphere of Influence
- Water
- Railroads
- County Boundaries

Figure 4 Transit Stops and Alternative B (Infill)

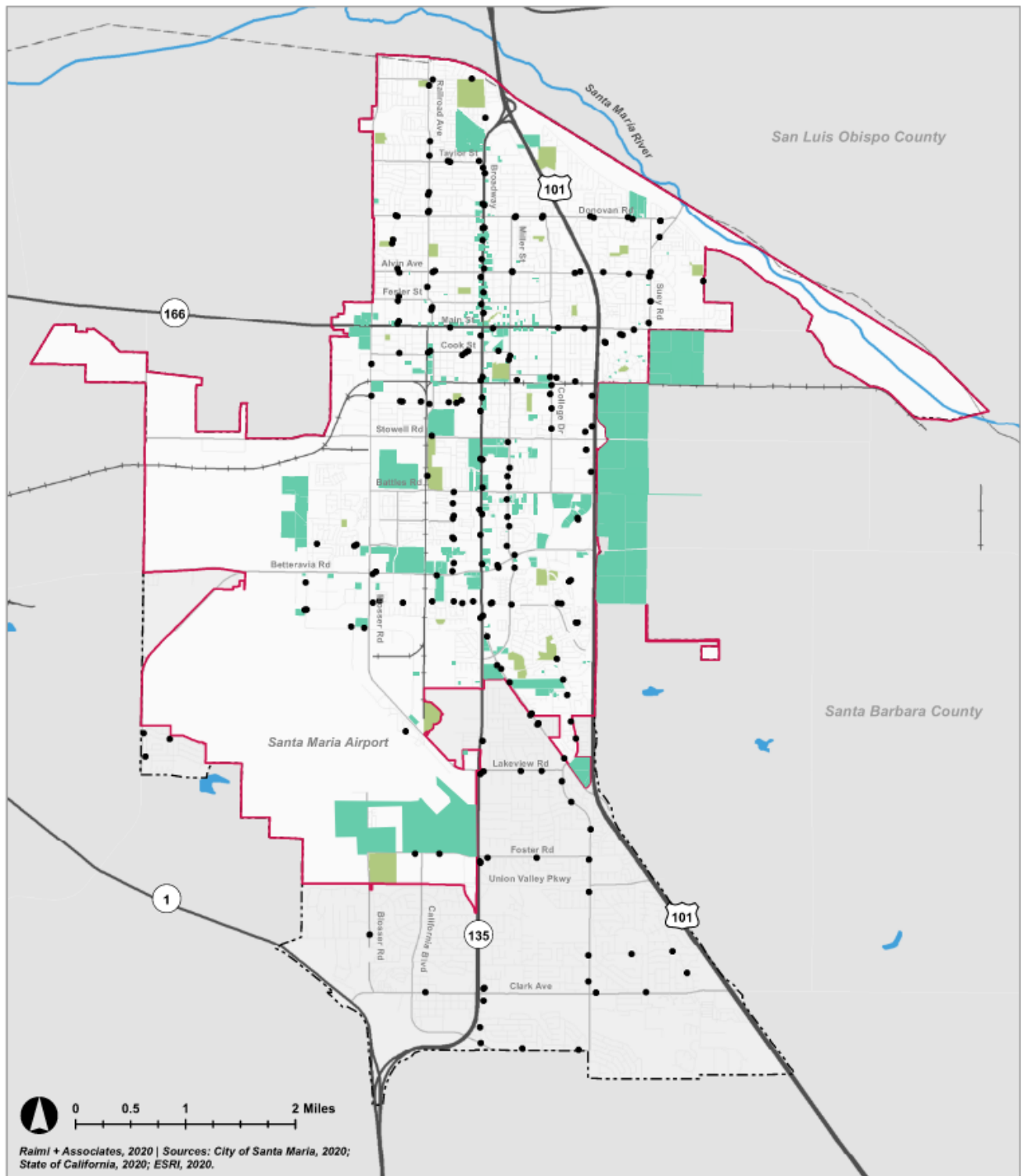

- Modified Parcel (Hybrid Alternative)
- Santa Maria City Limits
- Parks
- Transit Stop
- Sphere of Influence
- Water
- County Boundaries
- Railroads

Figure 5 Transit Stops and Alternative C (Hybrid)

2.2 Pedestrian and Bicycle Operations

2.2.1 Active Transportation Plan

The 2020 Active Transportation Plan was adopted by City Council in January 2021. This planning level study replaced the 2009 Bikeway Master Plan and is a performance-based plan following the six principles from the Smart Mobility Framework: Location Efficiency, Reliable Mobility, Health and Safety, Environmental Stewardship, Social Equity, and Robust Economy.

Table 1 shows the breakdown of existing and proposed length of bikeways by bikeway classification from the ATP. The total existing and proposed miles of bikeway in the city is 169.3 miles.

Table 1 Existing and Proposed Miles of Bikeways

Bikeway Class	Existing Miles	Recommendations		Total Existing + Proposed Miles
		Miles	# of Projects	
Class I Shared Use Paths	4.7 mi	21.6 mi	41	26.3 mi
Trails	7.1 mi	3.9 mi	1	11.0 mi
Class II Bicycle Lanes	80.4 mi	7.9 mi	17	88.3 mi
Class II Buffered Bike Lanes	0.3 mi	2.8 mi	3	3.1 mi
Class III Bicycle Routes	4.7 mi	20.2 mi	16	24.9 mi
Class IV Separated Bikeways	-	15.7 mi	26	15.66 mi
Total	97.2 mi	72.1 mi	104	169.3 mi

Some citywide projects were identified in the ATP. These include:

- Wayfinding programs,
- Bicycle parking,
- Bicycle detection at signalized intersections (accomplished with video detection),
- Pedestrian scale lighting (supports safer walkways), and
- Amenities (seating, shade, water fountains, and trash/recycling containers).

There were also suggested education and encouragement projects. Some of these projects are summarized below.

Education projects

- Streetsmarts campaign
- Bicycle safety education for adults
- Safe Routes to School
- Ticket diversion program

Encouragement Projects

- Bicycle and pedestrian coordinator
- Social walks/rides
- Adopt-a-Trail program
- Bike rack program
- Bicycle-friendly business program

2.2.2 Land Use Alternatives

2.2.2.1 Pedestrian Facilities

The proposed and existing pedestrian facilities are mapped, along with the three land use alternatives in **Figures 6, 7, and 8**. Many intersection crossing improvements are proposed, along with a Class I shared use path on Battles Road, the southern end of Broadway, and along the Santa Maria Valley Railroad Trail. In all the land use alternatives, there are not many existing or proposed pedestrian facilities. Pedestrian facilities will need to be added to service the modified parcels, especially for the annexed parcels in Alternatives A (Annex) and C (Hybrid).

2.2.2.2 Bicycle Facilities

The proposed and existing bicycle facilities are mapped, along with the three land use alternatives in **Figures 9, 10, and 11**. Bicycle facilities serve most of the parcels in the land use alternatives. However, the only bicycle facilities that service the annexed parcels Alternatives A (Annex) and C (Hybrid) are a proposed shared use path along the city border and a Class II bike lane along Betteravia Road. If either of these alternatives are chosen, bicycle facilities are recommended to service the annexed parcels.

2.2.2.3 Summary

There are several proposed bikeways, pedestrian facilities, and enhanced crossings from the ATP within the city limits but there are no improvements identified in the proposed areas of annexation in Alternatives A and C. If either of those land use alternatives are slated to move forward, further evaluation of the bicycle and pedestrian network (and recommended accommodations) will need to be performed.

Since Main Street and Broadway are under the jurisdiction of Caltrans, there are limited proposed improvements along these corridors. More improvements are suggested on lower speed and volume roadways. These roadways provide a better level of comfort but are not always the most convenient.

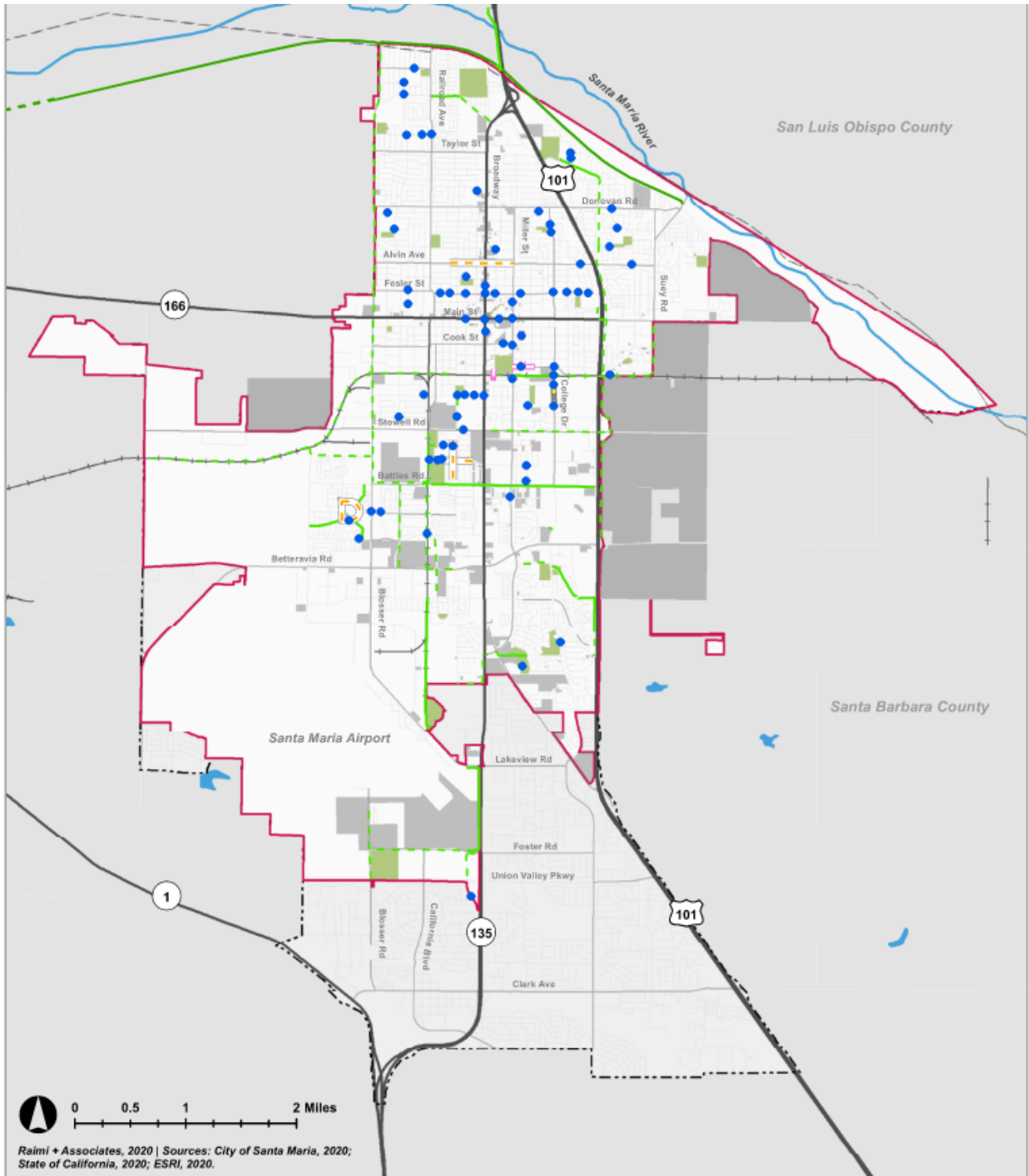

- | | | | |
|--------------------------------|-------------------------------------|--------------------------------|-------------------|
| ATP Proposed Facilities | Existing Facilities | Santa Maria City Limits | Parks |
| Class I Shared Use Path | Class I Shared Use Path | Santa Maria City Limits | Parks |
| Santa Maria Valley Levee Trail | Santa Maria Levee Trail | Sphere of Influence | Water |
| Lighting Improvement | Modified Parcel (Annex Alternative) | Railroads | County Boundaries |
| Traffic Calming | | | |
| Sidewalk | | | |
| Crossing Improvement | | | |

Figure 6 Existing and Proposed Pedestrian Facilities with Modified Parcels from Alternative A (Annex)

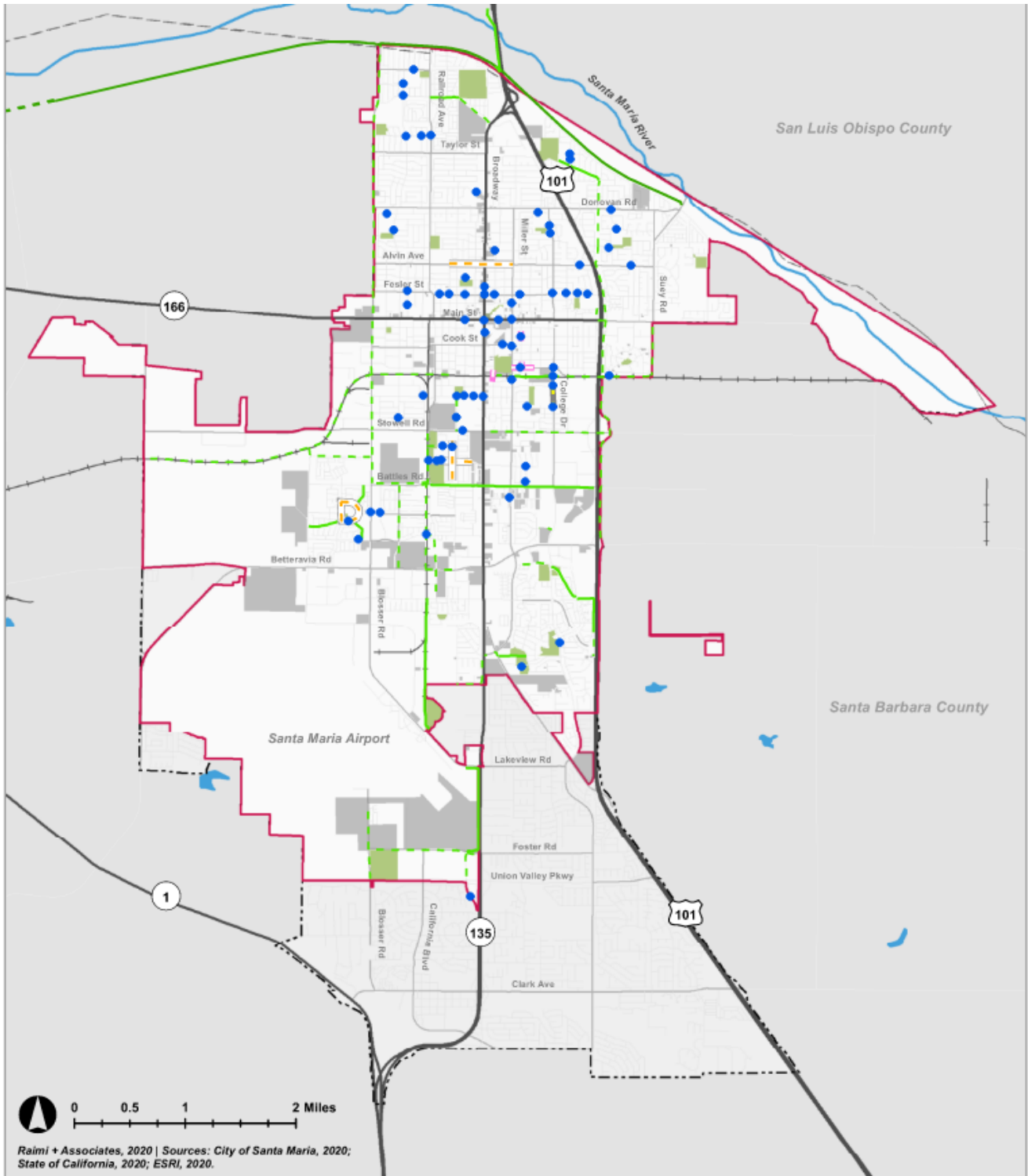

- | ATP Proposed Facilities | Existing Facilities | Santa Maria City Limits | Parks |
|--------------------------------|--------------------------------------|-------------------------|-------------------|
| Class I Shared Use Path | Class I Shared Use Path | Santa Maria City Limits | Parks |
| Santa Maria Valley Levee Trail | Santa Maria Levee Trail | Sphere of Influence | Water |
| Lighting Improvement | Modified Parcel (Infill Alternative) | Railroads | County Boundaries |
| Traffic Calming | | | |
| Sidewalk | | | |
| Crossing Improvement | | | |

Figure 7 Existing and Proposed Pedestrian Facilities with Modified Parcels from Alternative B (Infill)

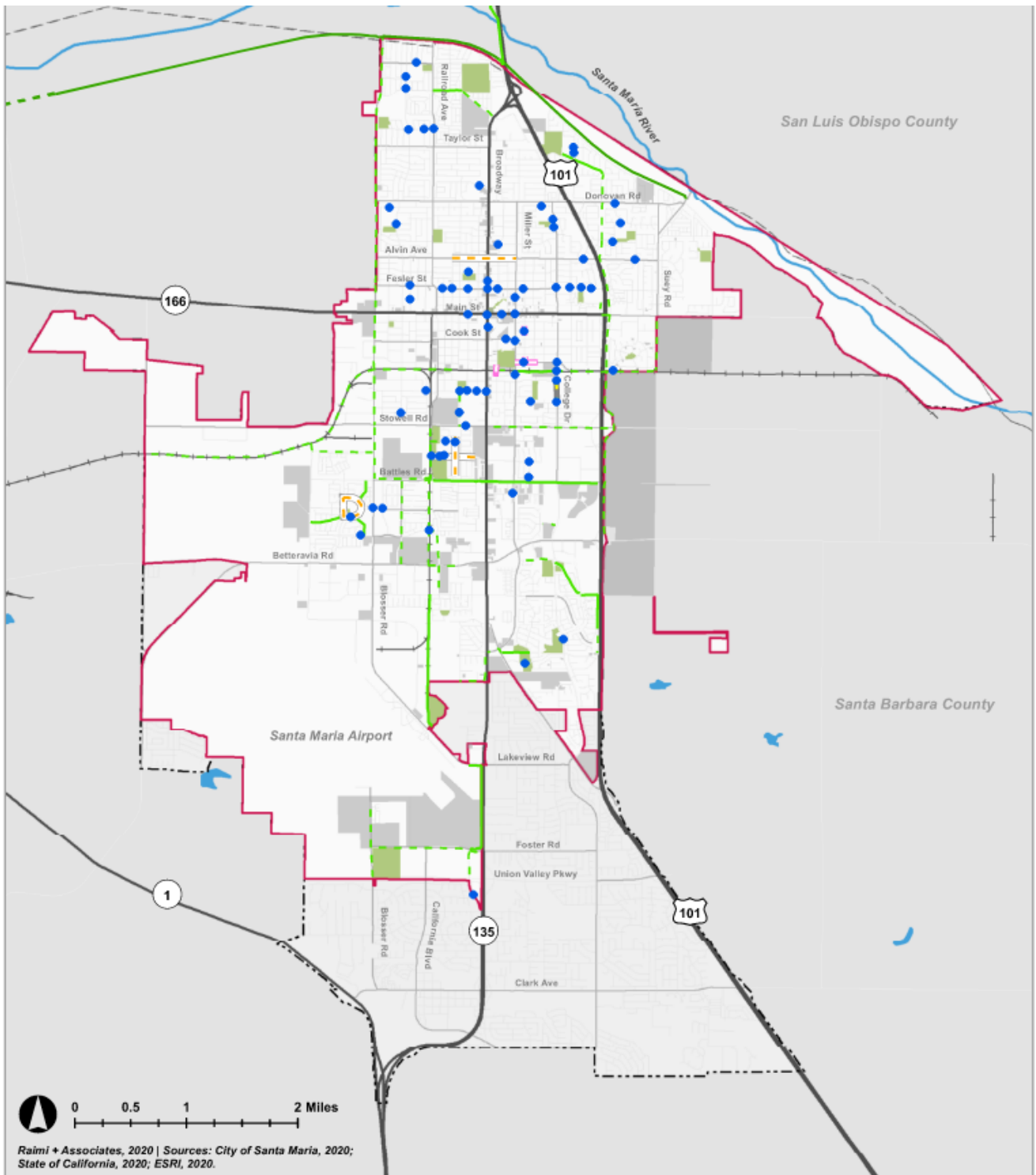

- | | | | |
|--------------------------------|--------------------------------------|--------------------------------|-------------------|
| ATP Proposed Facilities | Existing Facilities | Santa Maria City Limits | Parks |
| Class I Shared Use Path | Class I Shared Use Path | Santa Maria City Limits | Parks |
| Santa Maria Valley Levee Trail | Santa Maria Levee Trail | Sphere of Influence | Water |
| Lighting Improvement | Modified Parcel (Hybrid Alternative) | Railroads | County Boundaries |
| Traffic Calming | | | |
| Sidewalk | | | |
| Crossing Improvement | | | |

Figure 8 Existing and Proposed Pedestrian Facilities with Modified Parcels from Alternative C (Hybrid)

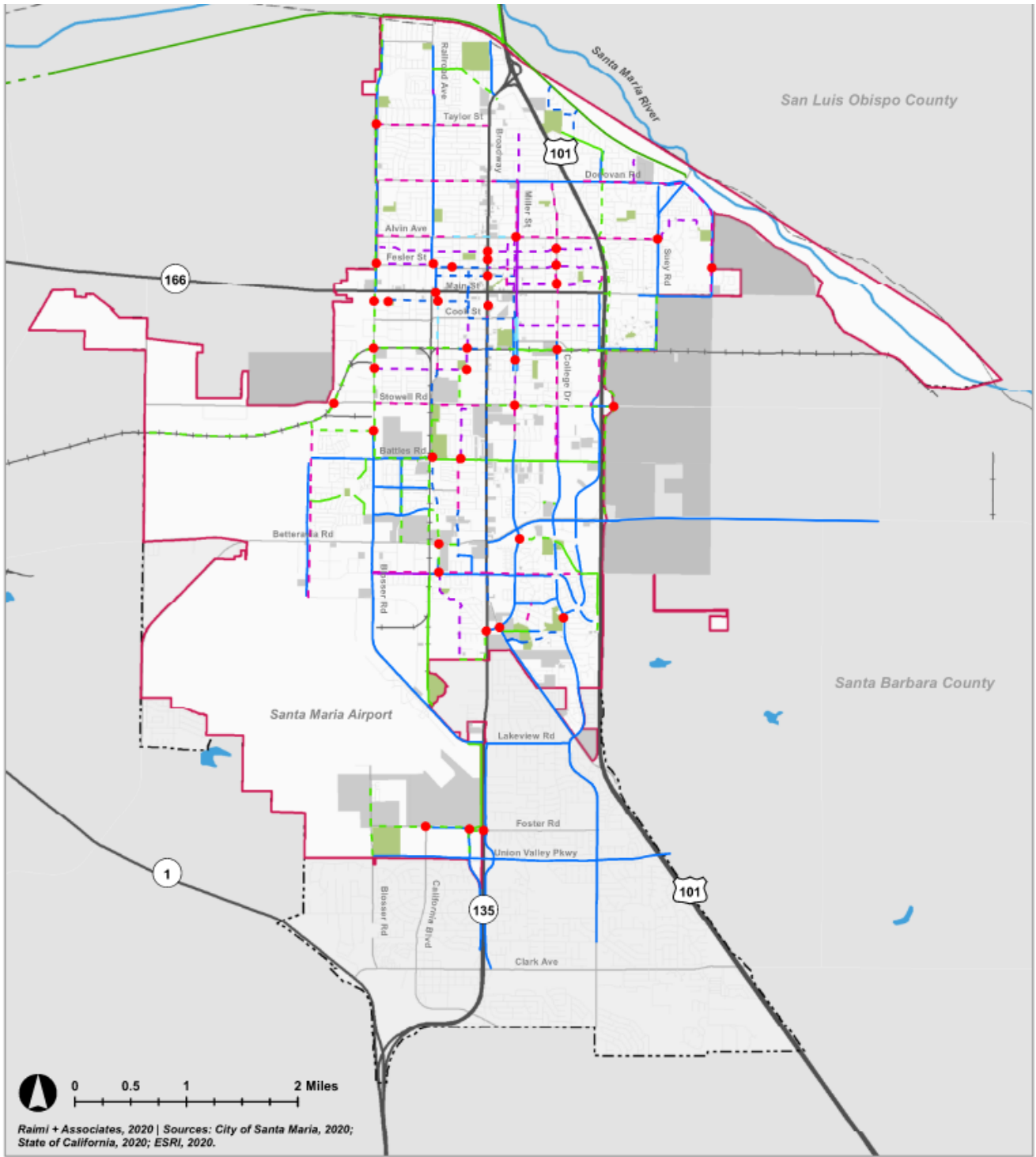

- | Proposed Facilities | | Existing Facilities | | | |
|---------------------|---------------------------------|---------------------|-----------------------------|--|-------------------------------------|
| | Class I Shared Use Path | | Class I Shared Use Path | | Modified Parcel (Annex Alternative) |
| | Class II Bicycle Lanes | | Class II Bike Lane | | Santa Maria City Limits |
| | Class II Buffered Bicycle Lanes | | Class II Buffered Bike Lane | | Sphere of Influence |
| | Class III Bicycle Route | | Class III Bike Route | | Railroads |
| | Class IV Separated Bikeway | | Santa Maria Levee Trail | | Parks |
| | Santa Maria Levee Trail | | | | Water |
| | Crossing Improvement | | | | County Boundaries |

Figure 9 Existing and Bicycle Facilities with Modified Parcels from Alternative A (Annex)

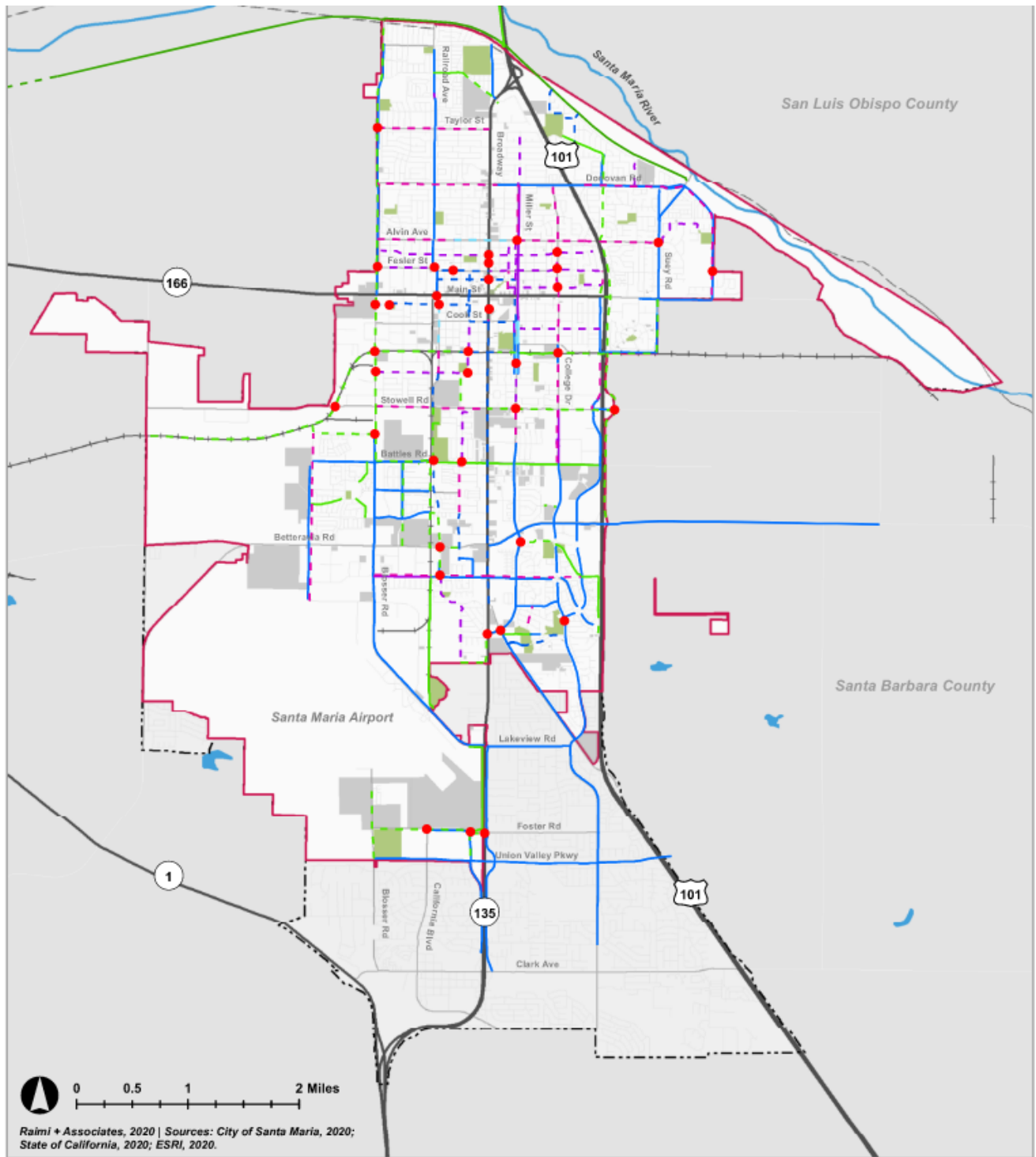

- | Proposed Facilities | | Existing Facilities | Modified Parcel (Infill Alternative) |
|---------------------------------|-----------------------------|-------------------------|--------------------------------------|
| Class I Shared Use Path | Class I Shared Use Path | Santa Maria City Limits | |
| Class II Bicycle Lanes | Class II Bike Lane | Sphere of Influence | Railroads |
| Class II Buffered Bicycle Lanes | Class II Buffered Bike Lane | Parks | Water |
| Class III Bicycle Route | Class III Bike Route | County Boundaries | |
| Class IV Separated Bikeway | Santa Maria Levee Trail | | |
| Santa Maria Levee Trail | | | |
| Crossing Improvement | | | |

Figure 10 Existing and Bicycle Facilities with Modified Parcels from Alternative B (Infill)

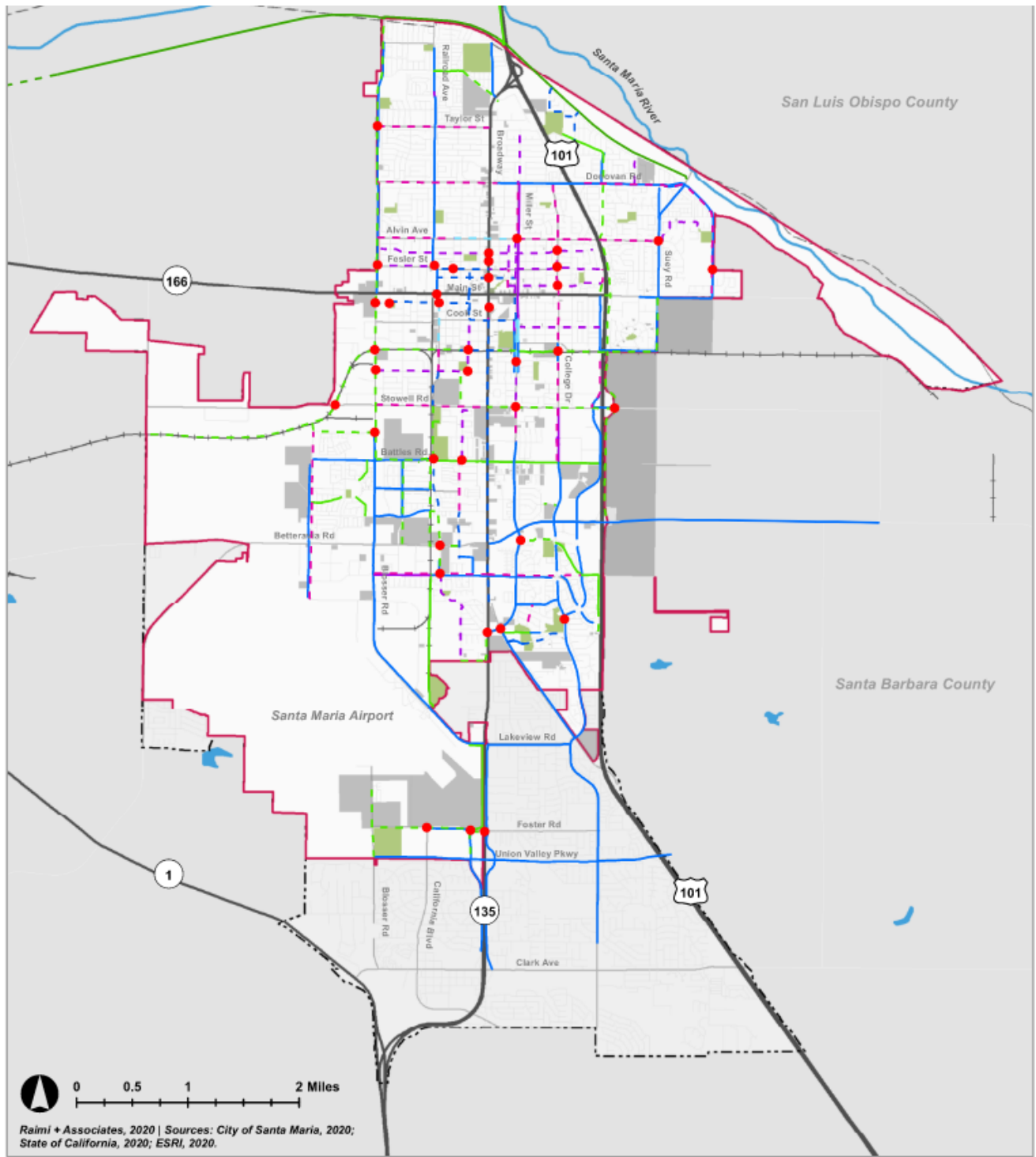

- | Proposed Facilities | | Existing Facilities | | |
|---|---|---|--|--|
| --- Class I Shared Use Path | --- Class I Shared Use Path | Modified Parcel (Hybrid Alternative) | Santa Maria City Limits | Sphere of Influence |
| --- Class II Bicycle Lanes | --- Class II Bike Lane | Railroads | Parks | Water |
| --- Class II Buffered Bicycle Lanes | --- Class II Buffered Bike Lane | County Boundaries | | |
| --- Class III Bicycle Route | --- Class III Bike Route | | | |
| --- Class IV Separated Bikeway | --- Santa Maria Levee Trail | | | |
| --- Santa Maria Levee Trail | | | | |
| ● Crossing Improvement | | | | |

Figure 11 Existing and Bicycle Facilities with Modified Parcels from Alternative C (Hybrid)

2.3 Planned or Constructed Road Diets

After identifying existing and proposed bikeways in the ATP, the city started to evaluate what roadways where bikeways could easily be added with a pavement rehabilitation and/or restriping project. These roadways are captured below with the tentative timeline.

1. N. Blosser Road, Atlantic to Taylor
 - Existing: Two lanes each direction
 - In Construction: One lane each direction. Raised median with turn pockets at intersections/driveways.
 - Impact: Reduces lanes for vehicles and speed management.
2. Depot Street, Stowell Road to Carmen Lane
 - Existing: Two lanes each direction
 - In Construction: Reduced to one lane each direction. Class IV bicycle facilities with on-street parking between Stowell and Battles. Buffered Class II facility between Battles and Carmen. Striped median/two-way left turn lanes where appropriate.
 - Impact: Reduces lanes for vehicles and adds buffered bicycle lanes.
3. Alvin Avenue, Blosser Road to Railroad Avenue
 - Existing: Two lanes each direction.
 - In Construction: One lane each direction with two-way left turn lane. Maintain on-street parking with a Buffered Class II facility.
 - Impact: Reduces lanes for vehicles and adds buffered bicycle lanes.
4. Pine Street, Main Street to Cook Street
 - Existing: Two lanes each direction.
 - In Construction: One lane each direction, add on-street parking and Class II facility.

The N. Blosser Road and Depot Street segments had existing roadway segment volume counts at select locations, which allowed for corresponding level of service (LOS) to be calculated. The conversion from a four-lane roadway to two-lane roadway at these locations resulted in minimal to no change in LOS. Overall, these roadways operated at an LOS of B or better for existing and all alternative scenarios.

2.4 Other Safety Recommendations

In providing overall safe and convenient accommodations for bicycle, pedestrian, and transit, it is important to understand that the lack of facilities coupled with higher speeds and higher volume roadways that create a less than desirable mode choice and have safety issues. A complete streets approach is recommended to provide these recommendations. These improvements can complement the needs with the roadway functional classification and have different intersection safety features that would improve access and remove barriers.

Arterial and Collector Roadways

- Wider sidewalks (6-10 feet) on both sides of the roadways and evaluate providing a sidepath (shared use path adjacent to roadway) where right of way allows
- Provide curb extensions where feasible in reducing the pedestrian's crossing distance and exposure to vehicles
- Dedicated bike lanes and buffered or protected bike lanes were feasible
- Green conflict markings for vehicle to bicycle mixing zones and evaluate providing a protected intersection
- At signalized intersections provide leading pedestrian intervals and video detection for bicycle detection
- Provide overall roadway geometrics (narrow lanes to support lower speeds overall speed management). This will help to remove barriers such as discontinuous routes or treacherous crossings with multiple conflicts points with vehicles.

- Provide planter buffers with trees for visually narrowing the roadway and lowering speeds.
- Enhanced lighting at the intersections, mid-block crossings, and along the corridor
- Pedestrian crossing enhancements at frequented locations
 - RRFBs, pedestrian hybrid beacons, high visibility crosswalk, yield lines, etc.
- Areas of gather and placemaking with benches, art, murals, and local flavor

Local Roadways

- Traffic calming measures to keep speed low
- Limited striping and bicycle pavement markings for shared use (sharrows).
- Dedicated bike lanes if feasible.
- Sidewalks and enhanced crossing treatments at major intersections and any attractions and destinations (schools, parks, churches, etc.)

As shown in the **Figure 12** below, the pedestrian-to-vehicle and bicycle- to-vehicle collisions, were primarily concentrated in the downtown core along Broadway and Main Street. Both these roadways are state highways that serve various transportations modes including heavy vehicles/trucks. Evaluating the appropriate facilities in these areas is important with the proposed increased housing and employment densities with all alternatives.

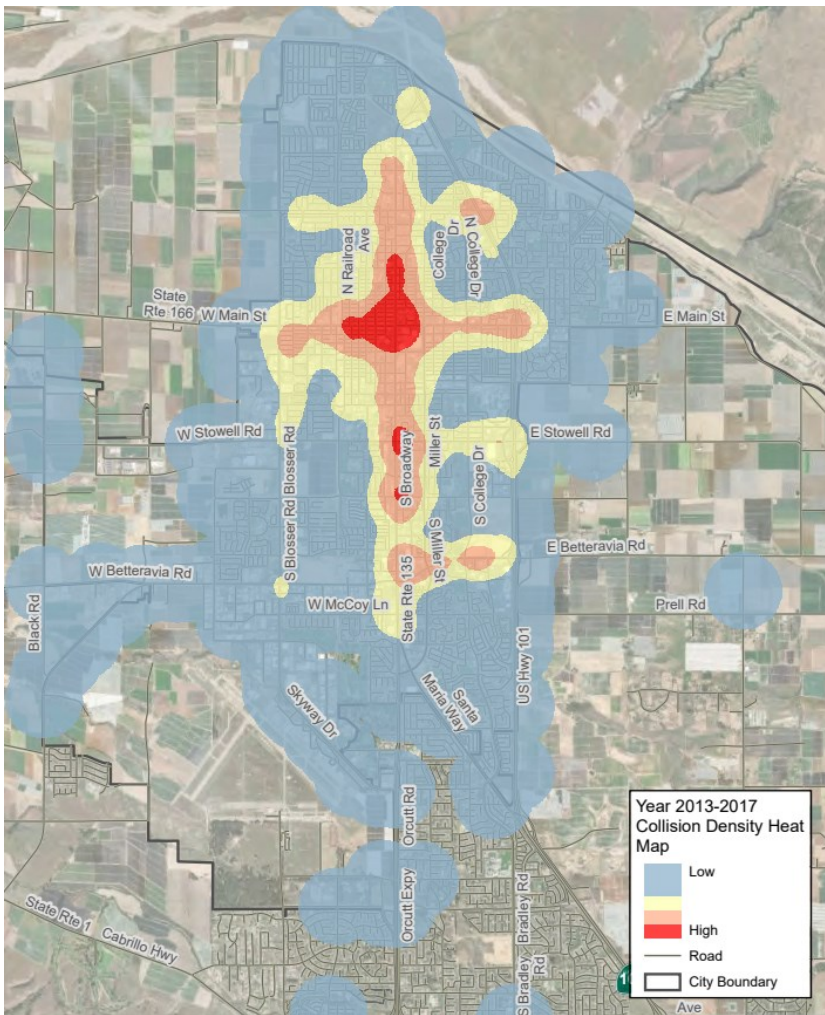

Figure 12 Pedestrian and Bicycle Collision Density (2013-2017)

2.5 Emerging Mobility

Emerging mobility covers different transportation options such as such as micromobility, Transportation Network Companies, autonomous/connected vehicles, smartphone app services, and ride sharing services. These options will affect the transportation network and future travel with less dependence on vehicle ownership. To date, the city doesn't have any shared bike or scooter services, but this could be a likely possibility in the future.

Per the Short Range Transit Plan, the goal is to have 100% of bus purchases be for zero emission buses by 2029 with a 100% zero emission bus fleet by 2040. These improvements are also coupled with the following recommendations:

- First/last mile solutions to get riders to bus stops
 - Examples: shared bike/scooter service, door-to-bus smartphone app, reservation-based/shared-ride transit service
- Automatic Vehicle Location (AVL) and Predictive Arrival
 - Variety of programs available to add to buses to monitor on-time performance using geographic data and schedules/actual time at each stop (automatic vehicle location)
 - There are also programs for passengers to see real-time bus data (predictive arrival)

3. Vehicular Traffic Assessment

3.1 Traffic Operations per Land Use Alternatives

3.1.1 Level of Service (LOS) at Select Locations

When comparing the LOS between the three scenarios (Annex, Infill, and Hybrid) for roadway segments with existing volumes, both the Annex and Infill scenarios are similar. However, the Annex scenario has better LOS for four more segments than Infill. The LOS for the three alternatives is displayed for select roadway segments in **Figures 13, 14, and 15**.

To view LOS for all analyzed locations, along with the associated forecasted volumes, see **Attachment 1**. For the locations with failing LOS, multimodal and emerging technology strategies can be analyzed to reduce the vehicular impact on the roadways. Overall, Alternative A (Annex) will have the least impact on existing roadways but will require new roadways with the land use change from agriculture to higher density land uses (residential, commercial, etc.).

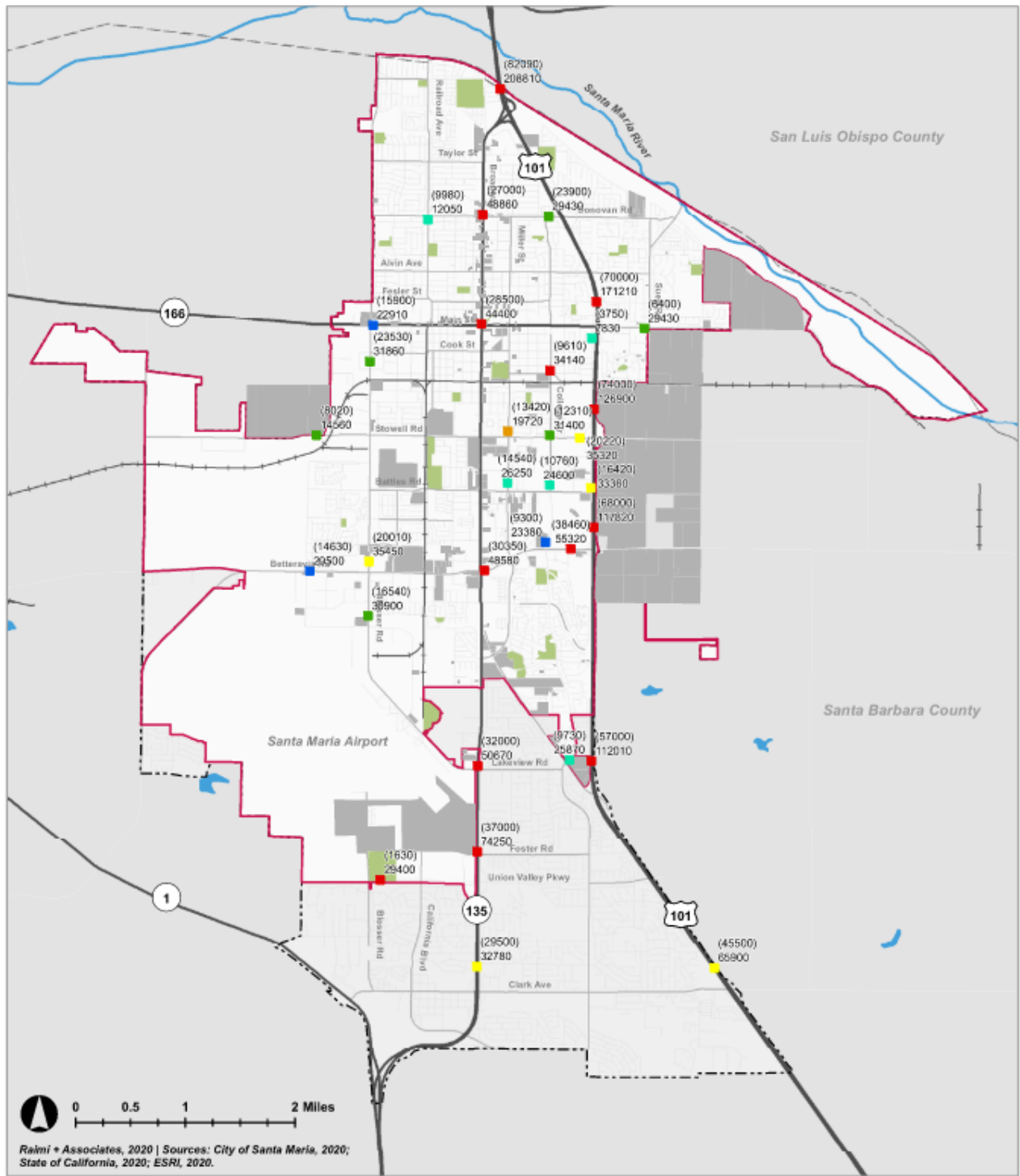

0 0.5 1 2 Miles

Raimi + Associates, 2020 | Sources: City of Santa Maria, 2020; State of California, 2020; ESRI, 2020.



- | Level of Service (LOS) | Label |
|------------------------|---------------------|
| ■ LOS A | ■ (Existing Volume) |
| ■ LOS B | ■ Projected Volume |
| ■ LOS C | |
| ■ LOS D | |
| ■ LOS E | |
| ■ LOS F | |

- | | |
|---------------------------------------|-------------------------|
| ■ Modified Parcel (Annex Alternative) | ■ Parks |
| — Santa Maria City Limits | ■ Water |
| - - - Sphere of Influence | - - - County Boundaries |
| — Railroads | |

Figure 13 Level of Service for Land Use Alternative A (Annex)

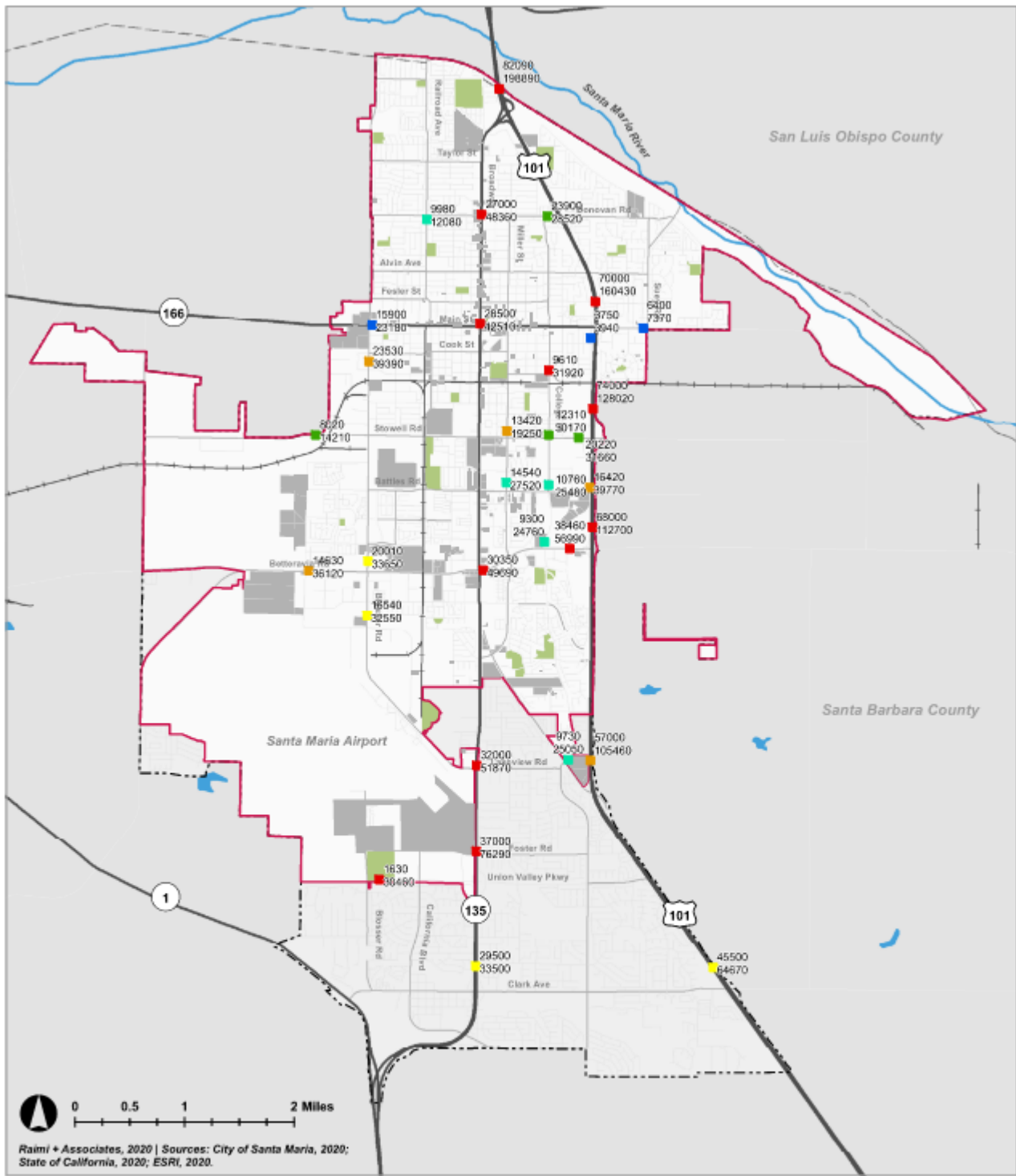

Level of Service (LOS)	Label
■ LOS A	■ (Existing Volume)
■ LOS B	■ Projected Volume
■ LOS C	
■ LOS D	
■ LOS E	
■ LOS F	

■ Modified Parcel (Infill Alternative)	■ Parks
— Santa Maria City Limits	■ Water
- - - Sphere of Influence	- - - County Boundaries
—+— Railroads	

Figure 14 Level of Service for Land Use Alternative B (Infill)

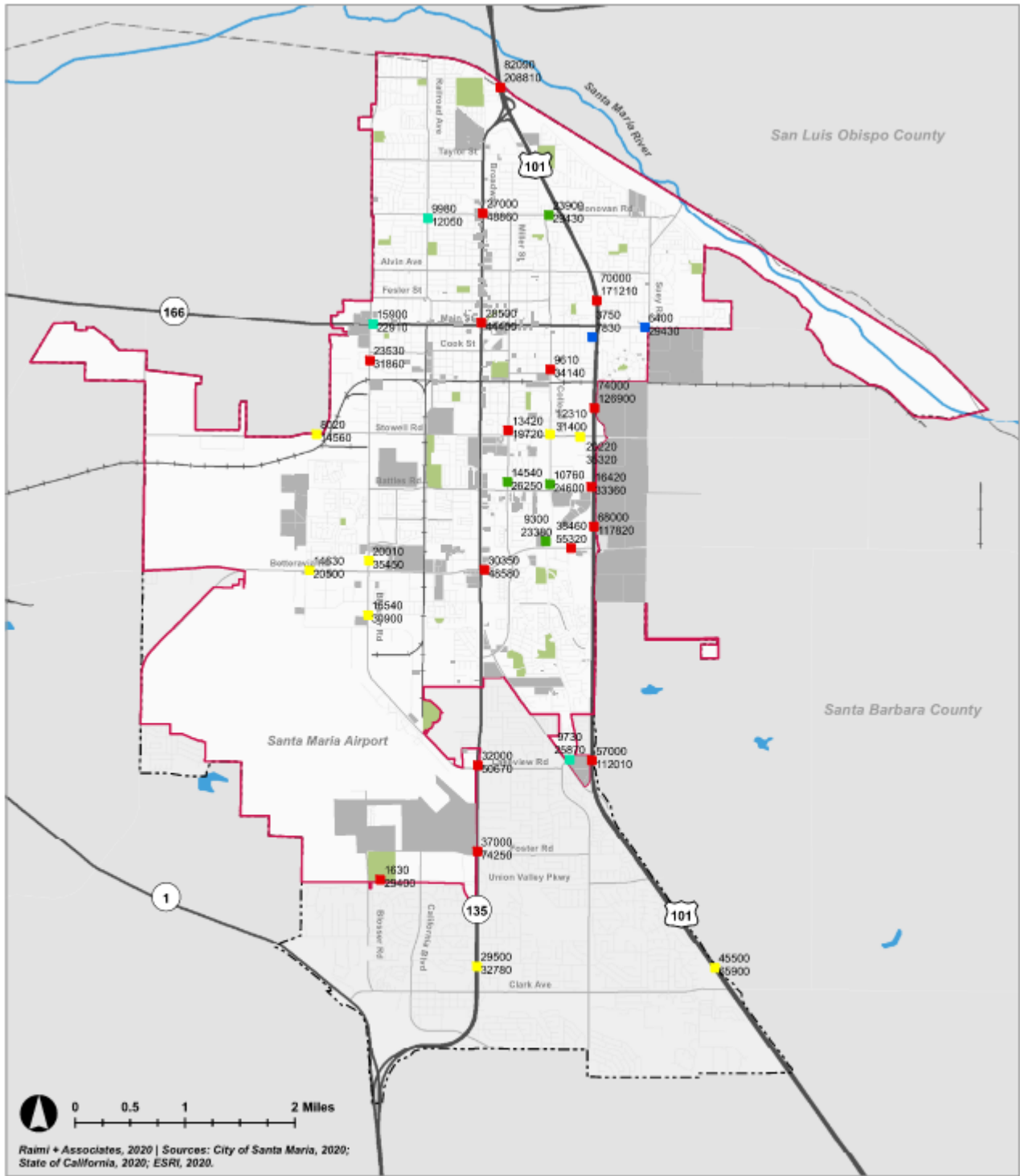

Level of Service (LOS)	Label
■ LOS A	■ (Existing Volume)
■ LOS B	■ Projected Volume
■ LOS C	
■ LOS D	
■ LOS E	
■ LOS F	

■ Modified Parcel (Hybrid Alternative)	■ Parks
— Santa Maria City Limits	■ Water
- - - Sphere of Influence	- - - County Boundaries
— Railroads	

Figure 15 Level of Service for Land Use Alternative C (Hybrid)

3.1.2 Vehicle to Capacity Ratio

Vehicle to Capacity Ratios (V/C Ratios) are a measure of effectiveness (MOE) in assessing vehicle congestion and delay. When a V/C ratio is 0.91 or higher, there will be unfavorable congestion and delay (level of service E or worse) with it failing once is greater than V/C ratio of 1 (amount of vehicles exceeds roadway capacity).

Therefore, this was used to compare the different land use alternatives. Using the city's traffic demand model, the current roadways in Santa Maria were compared. In general, the V/C Ratio is adequate at most city roadways with exceptions along US 101, SR 135, Main Street (SR 166), and Betteravia Road.

Mapped V/C Ratios for each land use alternative in the PM peak hour and daily volumes are included in **Attachment 2**. Out of the different land use alternatives, Alternative A (Annex) has the best V/C Ratio along the western end of Betteravia Road and Alternative B (Infill) has the best V/C Ratio along the western end of Main Street (SR 166) and the majority of US 101 in the city.

3.1.3 Vehicle Miles Traveled

Vehicle Miles Traveled (VMT) was assessed for all alternatives and is summarized in **Table 2** below. Per the results of this analysis, Alternative B (Infill) has the best VMT of the three alternatives per capita and household (HH). Alternative C (Hybrid) was developed by using the worst case of Alternative A (Annex) and Alternative B (Infill). Therefore, the VMT for this alternative was the highest per capita and household. However, in selecting a preferred land use alternative it is important to compare the overall increase of VMT to the base. With the proposed three land uses having an imbalance between jobs and housing, there is a significant increase in VMT with every alternative in comparison to the base scenario. It is recommended in the preferred alternatives that the land use follow the current Sustainable Communities Strategy (SBCAG 2050 RTP) that only allows jobs or housing in the future if they can be balanced.

Table 2 VMT Summary per Alternative

	2018 Base	2050 Annex	2050 Infill	2050 Hybrid
VMT/Capita	24.9	41.4	40.0	42.8
VMT/HH	75.2	116.9	112.2	120.7
VMT/Emp	84.1	116.3	120.5	117.4

Figure 16 shows the VMT by speed bin. The low VMT generating scenario, such as Alternative B (Infill) generates more volumes in high-speed bins (see speeds between 40 and 60 miles per hour (mph) in **Figure 16**). High VMT generating scenarios such as Alternative A (Annex) and Alternative C (Hybrid) generate more volumes in low-speed bins (see speeds between 0 and 35 mph in **Figure 16**).

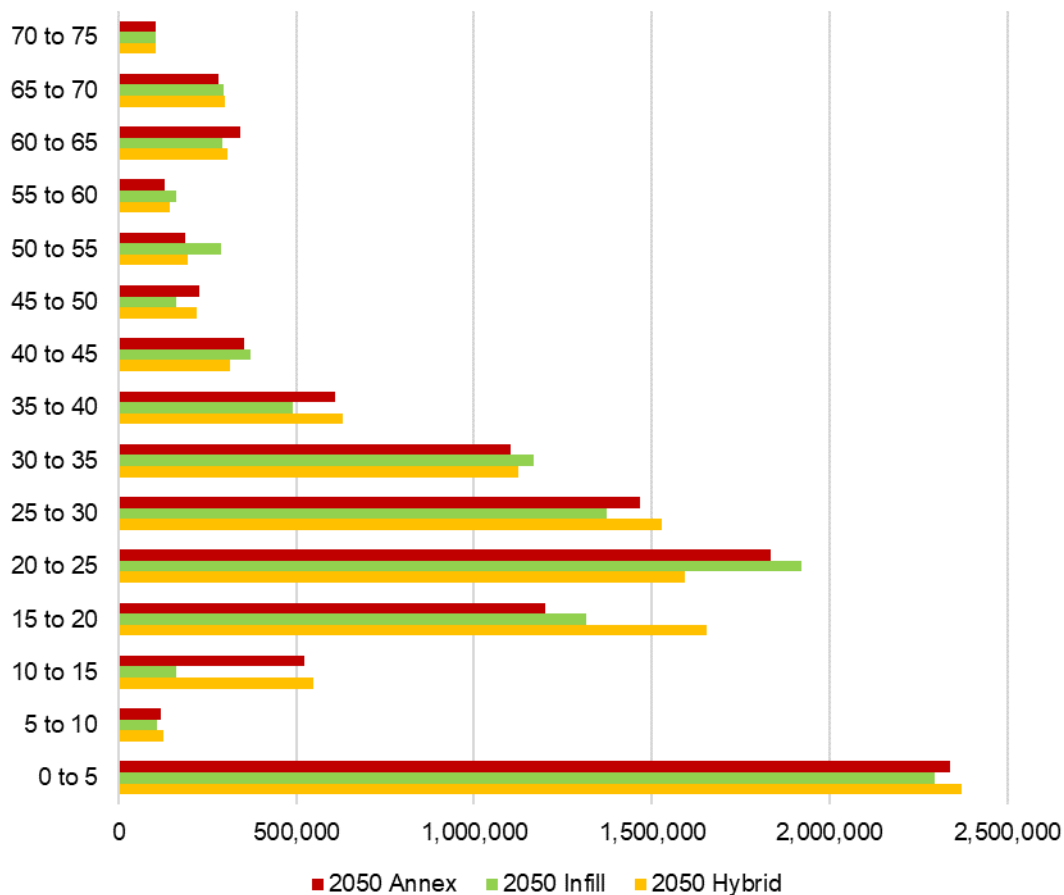

Figure 16 VMT by Speed Bin

3.2 Evaluate Functional Roadway Classifications for Declassification

Once the preferred alternative is selected, further evaluation will occur on city roadways in evaluating the appropriate functional roadway classification for the Circulation Element. Per city and Existing Conditions analysis, some roads may be declassified such as Alvin Avenue, Donovan Road, E Street, Black Road, and Mahoney Road.

- Alvin Avenue – Secondary Arterial functioning at LOS A in existing conditions and all three alternative scenarios for 2050
- Donovan Road, east of Broadway (SR 135) – Secondary Arterial functioning at LOS A in existing conditions and all three alternative scenarios for 2050
- E Street – No existing roadway segment volumes at this location
- Foster Road – Secondary Arterial functioning at LOS A in existing conditions but at LOS F in all three alternative scenarios for 2050
- Black Road – No existing roadway segment volumes at this location
- Mahoney Road – No existing roadway segment volumes at this location

3.3 Recommendations

The traffic needs from the base model and future (2050 SBCAG’s RTP forecast) scenarios show that US 101 north of Santa Maria would benefit from widening. US 101 through the City of Santa Maria widens to three lanes in each direction but drops back down to two lanes in each direction around the San Luis Obispo County

line. With the current push to reduce greenhouse gas emissions (GHGs), it is unlikely a widening project will occur so it will be important to identify alternative modes such as Bus Rapid Transit, commuter rail, or ride sharing services.

4. Transportation Policies

There were no distinguishable traffic differentiators to the three alternatives in relation to the congestion on the roadways. Therefore, it is recommended that the city implement various transportation policies that guide and lead the transportation infrastructure and complement the various recommendations from the city plans.

4.1 Reduce Vehicle Miles Traveled

Support mixed use developments with infrastructure that supports all transportation modes.

In July 2017, California passed assembly bill (AB) 398 to reauthorize the state's economy-wide greenhouse gas (GHG) reduction program. The goal is to reduce GHG of at least 40% before the 1990 level of emissions by 2030. In order to comply with the state's greenhouse gases reduction metrics by 2030, it is important to create sustainable transportations systems for all modes with mixed land uses in reducing the overall need to travel.

In addition, Senate Bill (SB) 743 was signed into law in 2013, with the intent to better align CEQA practices with statewide sustainability goals related to efficient land use, greater multimodal choices, and greenhouse gas reductions. The provisions of SB 743 became effective Statewide on July 1, 2020. Under SB 743, automobile delay, traditionally measured as level of service (LOS), are no longer considered an environmental impact under CEQA. Instead, impacts are determined by changes to VMT. Based on Office of Planning and Research (OPR) guidance, this project would likely be screened out (see below).

4.2 Speed Management

Implement a Citywide speed management policy and program.

There is a direct correlation between vehicle speeds and pedestrian and bicycle injury or death. Therefore, it is important to have a transportation system that has the correct geometrics and safety improvements in place to control speeds. In addition, additional enforcement and speed education are important in managing speeds.

4.3 Road Diets

Implement a Road Diet Policy in Reallocating Space for Alternative Transportation Modes

Road diets can reallocate travel lanes to space for alternative modes of transportation (bicycle lanes, transit lanes, and bus turnouts). Most common applications include converting a four-lane roadway to a three-lane roadway with a two-way left turn lane (TWLTL). **Figure 17** shows a road diet with adjacent parallel parking.



Figure 17 Cross Section of a Road Diet Concept

Road diets can also improve safety by reducing the vehicle conflict points for left-turning movements at intersections and driveways. On a four-lane divided road, left-turning traffic from the major street must store in

the through lane before making the turn. In addition, vehicles turning left out of the minor street or driveway will have to cross additional lanes and have more conflict points. A road diet can reduce the travel lanes a vehicle must cross and provide a painted median storage (TWLTL) for a vehicle to make a two-stage crossing.

4.3.1 Average Daily Traffic (ADT) Volume Consideration

FHWA advises that roadways with ADT of 20,000 vpd or less may be good candidates for a road diet and should be evaluated for feasibility. With a road diet, it is important to evaluate the intersections along the corridor, as well as the segments, as they can act as the bottlenecks. Therefore, road diets should consider additional intersection operational improvements.

4.3.1.1 Level of Service Analysis at Select Roadway Segments

Several roadway segments were identified in the Existing Conditions report for potential road diets. The LOS was determined using existing and forecasted ADT volumes. The resulting LOS for each of the alternatives are shown in **Table 3**. For all but seven locations, the LOS was A for the existing and alternative scenarios, keeping lane geometry the same.

The locations classified as four-lane, secondary arterial from **Table 3** were further analyzed to evaluate the difference in LOS if the number of lanes reduced to two. The results from this analysis are displayed in **Table 4**. Out of the 30 locations analyzed, 8 locations have a failing LOS after reducing the number of lanes in future scenarios. Those locations that fail in 2050 should be evaluated during the growth of the City as currently the traffic volumes support a road diet.

Table 3 Level of Service at Select Roadway Segments

City of Santa Maria Roadway Inventory												
Characteristics				Year	Existing		2050 Annex		2050 Infill		2050 Hybrid	
Road	Location	Facility Type	Lanes		Volume	LOS	Volume	LOS	Volume	LOS	Volume	LOS
Main St (SR 166)	E. of Suey Rd	Arterial	4 (TWLTL)	2015	6,400	A	29,430	C	7,370	A	19,150	A
Main St (SR 166)	W. of Suey Rd	Arterial	4 (TWLTL)	2018	8,700	A	29,260	C	10,250	A	18,830	A
A St	S. of Betteravia Dr	Secondary Arterial	2 (TWLTL)	2015	3,450	A	4,120	A	4,850	A	4,590	A
A St	S. of Sonya Ln	Secondary Arterial	2	2019	3,650	A	5,690	A	10,420	A	9,410	A
Alvin Ave	W. of Railroad Ave	Secondary Arterial	4	2018	8,510	A	9,620	A	9,180	A	10,000	A
Alvin Ave	W. of College Dr	Secondary Arterial	4	2018	7,700	A	15,620	A	12,850	A	14,730	A
Alvin Ave	E. of Bradley Rd	Secondary Arterial	4	2018	6,670	A	14,550	A	11,720	A	13,640	A
Alvin Ave	W. of Suey Rd	Secondary Arterial	4	2018	3,440	A	9,760	A	7,050	A	8,670	A
Battles Rd	E. of Blosser Rd	Secondary Arterial	4	2018	10,740	A	13,690	A	15,610	A	15,810	A
Battles Rd	W. of Blosser Rd	Secondary Arterial	4	2018	9,320	A	10,370	A	14,400	A	14,140	A
Battles Rd	W. of Bradley Rd	Secondary Arterial	4	2018	7,670	A	17,170	A	28,320	C	28,470	C
Battles Rd	W. of Broadway (SR 135)	Secondary Arterial	4	2019	11,650	A	12,700	A	13,680	A	14,120	A
Blosser Rd	N. of Taylor St	Secondary Arterial	2	2015	5,120	A	5,930	A	6,000	A	6,360	A
Blosser Rd	S. of Taylor St	Secondary Arterial	4	2018	7,970	A	13,010	A	13,390	A	14,500	A
Blosser Rd	N. of Canal St	Secondary Arterial	2	2018	2,700	A	2,610	A	2,690	A	2,790	A
Bradley Rd	S. of Cottage Ln	Secondary Arterial	4 (TWLTL)	2018	1,000	A	5,030	A	4,430	A	5,250	A
Bradley Rd	S. of Bello Rd	Secondary Arterial	4 (TWLTL)	2019	4,960	A	6,360	A	5,800	A	6,200	A
Bradley Rd	E. of College Dr	Secondary Arterial	2	2015	3,950	A	3,950	A	3,950	A	3,950	A
Bradley Rd	S. of Battles Rd	Secondary Arterial	4 (TWLTL)	2018	10,760	A	18,410	A	13,460	A	15,670	A
College Dr	N. of Battles Rd	Secondary Arterial	4 (divided)	2018	10,760	A	24,600	B	25,480	B	28,330	C
College Dr	N. of Main (SR 166)	Secondary Arterial	4 (TWLTL)	2019	8,620	A	20,780	A	18,820	A	21,930	A
College Dr	N. of Alvin Ave	Secondary Arterial	4	2015	5,820	A	12,940	A	12,540	A	13,930	A
College Dr	S. of Donovan Rd	Secondary Arterial	4	2018	8,020	A	14,230	A	13,810	A	15,100	A
Cook St	W. of Broadway (SR 135)	Collector	4 (divided)	2017	8,870	A	11,090	A	12,190	A	12,420	A
Cook St	E. of Broadway (SR 135)	Collector	4 (divided)	2018	8,990	A	11,550	A	11,810	A	11,610	A
Depot St	N. of Carmen Ln	Secondary Arterial	4	2015	4,500	A	6,020	A	5,870	A	6,420	A
Depot St	N. of Battles Rd	Secondary Arterial	2	2018	10,450	B	9,070	A	8,610	A	9,880	B
Depot St	N. of Stowell Rd	Secondary Arterial	4	2018	9,560	A	16,660	A	20,860	A	21,560	A
Donovan Rd	W. of Railroad Ave	Secondary Arterial	4	2018	11,580	A	14,490	A	16,130	A	15,970	A
Donovan Rd	W. of Suey Rd	Secondary Arterial	4	2018	7,530	A	8,980	A	7,650	A	9,190	A
Fesler St	E. of Broadway (SR 135)	Secondary Arterial	4	2018	5,640	A	11,950	A	10,980	A	11,870	A
Fesler St	W. of Broadway (SR 135)	Secondary Arterial	4	2015	6,880	A	12,230	A	13,730	A	13,590	A
McCoy Ln	E. of Skyway Dr	Secondary Arterial	4 (TWLTL)	2018	11,850	A	15,240	A	16,170	A	16,300	A
McCoy Ln	E. of College Dr (roundabout)	Secondary Arterial	4	2015	5,330	A	5,400	A	5,370	A	5,410	A
McCoy Ln	W. of College Dr (roundabout)	Secondary Arterial	4	2019	6,380	A	12,350	A	13,320	A	13,680	A
Panther Dr	S. of Suey Crossing Rd	Secondary Arterial	4	2015	4,810	A	6,250	A	5,720	A	6,040	A
Santa Maria Wy	S. of Miller Wy	Secondary Arterial	4 (divided)	2017	10,470	A	21,810	A	22,050	A	22,900	A
Santa Maria Wy	S. of Dauphin St	Secondary Arterial	4 (divided)	2018	10,420	A	22,890	A	22,710	A	24,910	B
Stowell Rd	W. of Blosser Rd	Secondary Arterial	4 (TWLTL)	2018	9,510	A	27,160	B	21,850	A	24,190	B
Suey Rd	N. of Main (SR 166)	Secondary Arterial	2	2018	7,590	A	10,740	A	10,180	A	11,320	A
Suey Rd	N. of Alvin Ave	Secondary Arterial	4	2019	4,850	A	9,140	A	8,280	A	9,100	A
Union Valley Parkway	W. of Orcutt Expressway (SR 135)	Primary Arterial	4 (divided)	2015	5,990	A	35,670	D	36,410	E	36,490	E

Bold text = LOS is not A

Table 4 Resulting LOS from Two-Lane Reduction at Four-Lane Secondary Arterials

City of Santa Maria Roadway Inventory							
Existing Characteristics		2050 Annex LOS		2050 Infill LOS		2050 Hybrid LOS	
Road	Location	No Change	Reducing Lanes	No Change	Reducing Lanes	No Change	Reducing Lanes
Alvin Ave	W. of Railroad Ave	A	A	A	A	A	A
Alvin Ave	W. of College Dr	A	C	A	B	A	C
Alvin Ave	E. of Bradley Rd	A	C	A	A	A	B
Alvin Ave	W. of Suey Rd	A	A	A	A	A	A
Battles Rd	E. of Blosser Rd	A	B	A	C	A	C
Battles Rd	W. of Blosser Rd	A	A	A	C	A	C
Battles Rd	W. of Bradley Rd	A	D	C	F	C	F
Battles Rd	W. of Broadway (SR 135)	A	B	A	B	A	C
Blosser Rd	S. of Taylor St	A	B	A	B	A	C
Bradley Rd	S. of Cottage Ln	A	A	A	A	A	A
Bradley Rd	S. of Bello Rd	A	A	A	A	A	A
Bradley Rd	S. of Battles Rd	A	E	A	B	A	C
College Dr	N. of Battles Rd	B	F	B	F	C	F
College Dr	N. of Main (SR 166)	A	F	A	E	A	F
College Dr	N. of Alvin Ave	A	B	A	B	A	B
College Dr	S. of Donovan Rd	A	C	A	B	A	C
Depot St	N. of Carmen Ln	A	A	A	A	A	A
Depot St	N. of Stowell Rd	A	D	A	F	A	F
Donovan Rd	W. of Railroad Ave	A	C	A	D	A	C
Donovan Rd	W. of Suey Rd	A	A	A	A	A	A
Fesler St	E. of Broadway (SR 135)	A	A	A	A	A	A
Fesler St	W. of Broadway (SR 135)	A	B	A	B	A	B
McCoy Ln	E. of Skyway Dr	A	C	A	D	A	D
McCoy Ln	E. of College Dr (roundabout)	A	A	A	A	A	A
McCoy Ln	W. of College Dr (roundabout)	A	B	A	B	A	B
Panther Dr	S. of Suey Crossing Rd	A	A	A	A	A	A
Santa Maria Wy	S. of Miller Wy	A	F	A	F	A	F
Santa Maria Wy	S. of Dauphin St	A	F	A	F	B	F
Stowell Rd	W. of Blosser Rd	B	F	A	F	B	F
Suey Rd	N. of Alvin Ave	A	A	A	A	A	A

Failing LOS (LOS E or LOS F)

4.3.2 Changes to Typical Sections

Encouraging a mode shift is recommended due to the increased impact of vehicles in the future scenario. One strategy to reduce the vehicular impact on the roadways is installing increased multimodal infrastructure.

Currently, the city's Standard Drawings for typical sections are provided by land use, including residential, commercial, and industrial. These standard drawings are similar in nature and have limited accommodations for alternate modes of travel, especially bicycles (see **Figures 18, 19, 22 and 23** below). Existing residential and commercial typical sections are identical, except for sidewalk and ROW width. Proposed alternative typical sections are proposed for commercial and residential land uses to provide a better level of traffic stress for bicycles. Some proposed changes to accommodate these alternate modes are displayed in **Figures 20, 21, and 24**. These typical sections show what can be done to repurpose the outside lanes for bikeways. With many of the city roadways varying in width, it will be important to evaluate each roadway on a case by case basis with the traffic volumes and current cross section.

Secondary Arterial

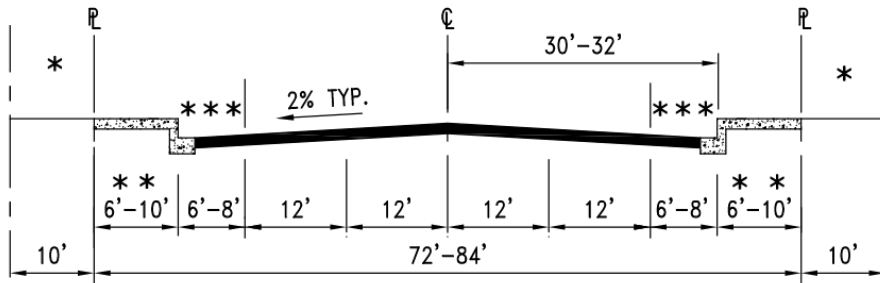

Figure 18 Existing Typical Section for Secondary Arterial (Residential Street)

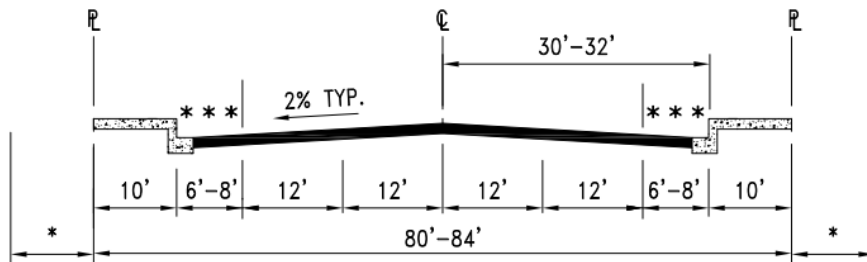

Figure 19 Existing Typical Section for Secondary Arterial (Commercial Street)

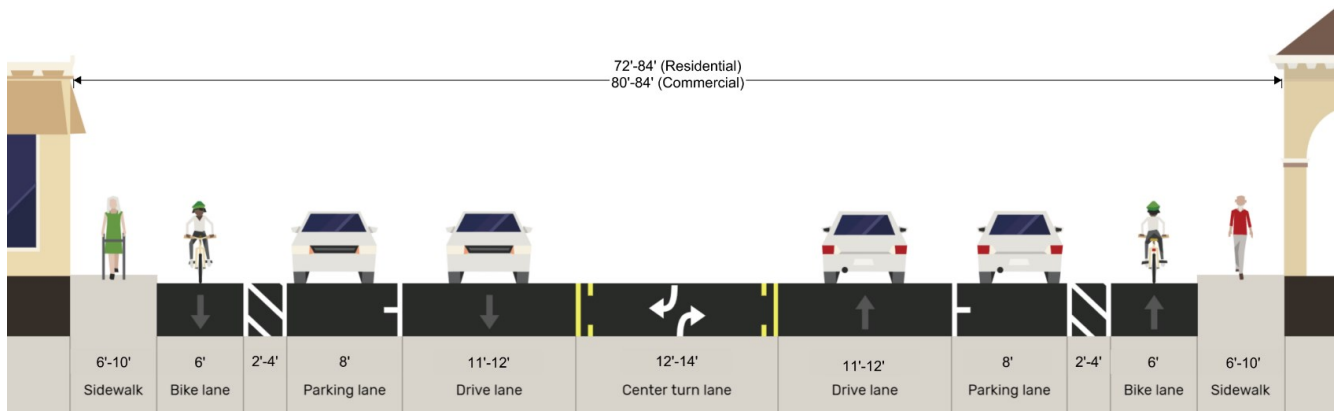

Figure 20 Proposed Typical Section for Secondary Arterial (Parking-Protected Bike Lanes)

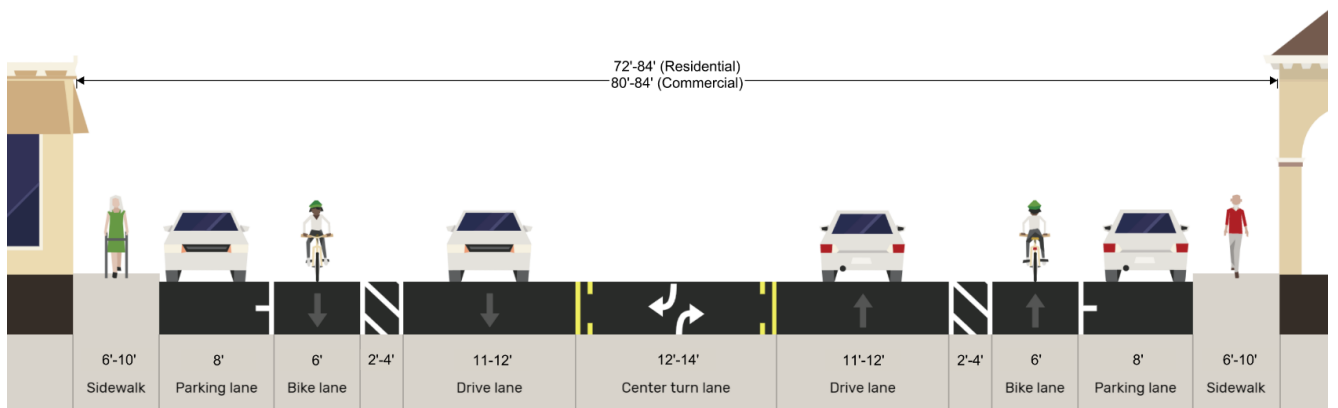

Figure 21 Proposed Typical Section for Secondary Arterial (Buffered Bike Lanes and Parking)

Primary Arterial

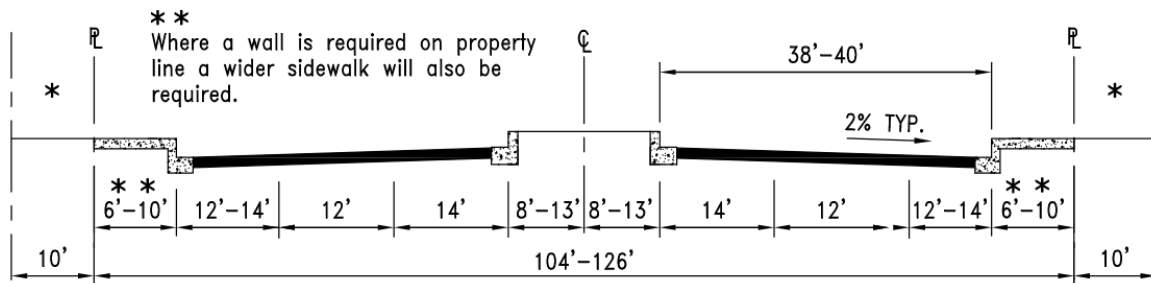

Figure 22 Existing Typical Section for Primary Arterial (Residential Street)

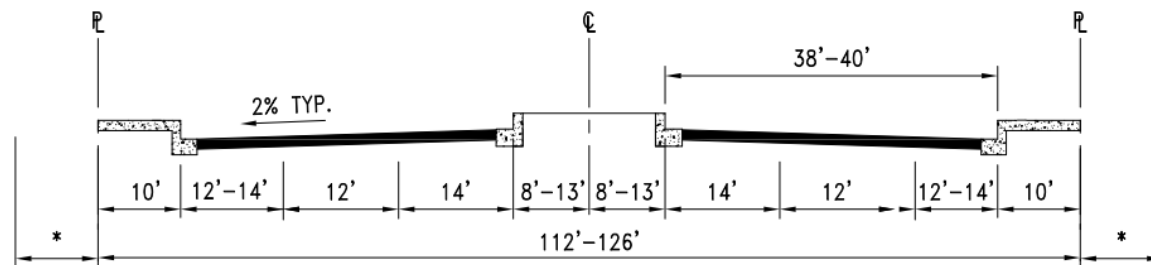

Figure 23 Existing Typical Section for Primary Arterial (Commercial Street)

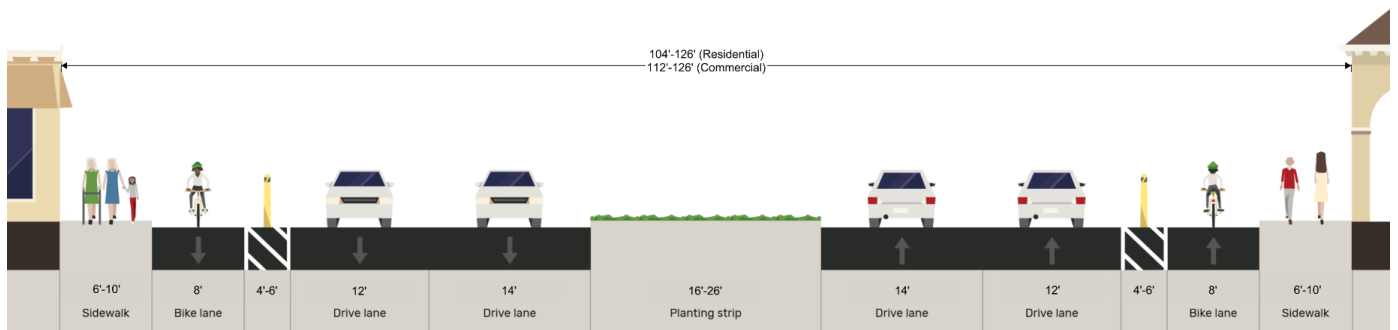

Figure 24 Proposed Typical Section for Primary Arterial (Bicycle Lane with Raised Buffer)

Figure 23 show how you can repurpose space on wider arterials for a protected bike lane. Primary arterials typically have higher speeds and volumes so need a higher degree of protection from vehicles. In addition, lanes can be narrowed based on the vehicle needs (lower truck and heavy vehicle volumes support 11' lanes).

4.3.3 Peak Hour Volume Feasibility

The peak hour volume in the peak direction will be the measure of volume driving the analysis and can determine where the Road Diet can be feasibly implemented. See **Table 5** below for FHWA's road diet feasibility based on vehicle per hour per direction (vphpd) thresholds during the peak hour.

Table 5 FHWA Road Diet Feasibility

Feasibility	Thresholds During the Peak hour
Probably feasible	≤ 750 vphpd
Consider cautiously	750 – 875 vphpd
Feasibility Less Likely	≥ 875 vphpd

4.4 Emerging Technologies

Support and implement projects with emerging technologies for improved multimodal operations.

Emerging technologies can include converting the existing traffic signals with inductive loop detection to video detection for bicycle detection. In addition, with new controllers at the signalized locations, leading pedestrian intervals can be implemented in giving the pedestrians 5 seconds of time before the vehicles, to establish their right of way in the crosswalks.

4.4.1 Transit Priority Routes

Prioritizing alternative modes can reduce vehicle congestion and greenhouse gases in high-density land use areas that support transit priority routes such as Broadway. **Figure 23** shows an example of a typical section for a primary arterial that dedicates a travel lane to buses (red bus lane). This typical section will be especially important along the Broadway corridor in the Infill Alternatives where there is proposed much high land use densities and a major bus route.

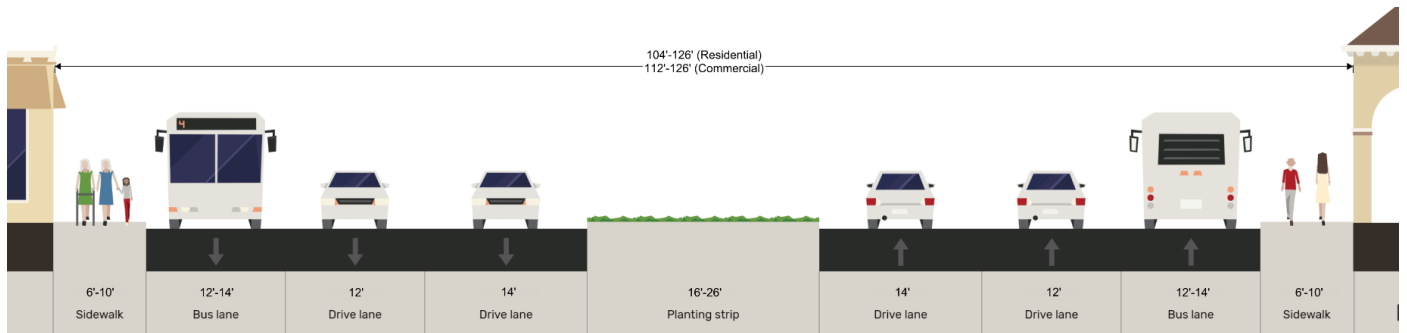

Figure 25 Proposed Typical Section for Primary Arterial (Transit Only Lane)

5. Conclusion

The results of the assessed information from this memorandum are summarized in matrix format in **Table 6**. These results are categorized from best to worst alternative, given the corresponding analysis scenario. According to this matrix, Alternative B (Infill) is the recommended alternative. However, Alternative B (Infill) has significant VMT increase when compared to the original Base model. This VMT increase is not favorable to decreasing GHGs. It is suggested that the preferred infill alternative follow the Sustainable Communities Strategy which promotes growth based on a balance between housing and jobs.

Table 6 Alternatives Evaluation Matrix

	Alternative		
	Annex	Infill	Hybrid
VMT/Capita			
Congestion			
Pedestrian, Bicycle, & Transit Facilities			

Legend: Best Worst

Per the model, with the anticipated growth in 2050 for any land use scenario, many roadways will reach or exceed capacity thresholds. Therefore, it is very important to provide alternative modes of transportation as a priority, which shifts vehicle traffic to transit, biking, or walkable trips.

From the level-of-service analysis, several roadways in Santa Maria have opportunities for road diets based on the existing and forecasted future volumes. A road diet can allow bikeways to be added with minimal cost and provide connectivity in the transportation system. With the suggested new typical sections for the secondary arterial, evaluation of the current road cross section would need to be further assessed to see what could feasibly be accommodated. These roadways could still function as a secondary arterial versus a collector roadway but can have the additional lanes repurposed for alternative modes.

Attachment 1

Roadway Level-of-Service

City of Santa Maria Roadway Inventory													
Characteristics					Existing			2050 Annex		2050 Infill		2050 Hybrid	
Road	Direction	Location	Facility Type	Lanes	Year	Volume	LOS	Volume	LOS	Volume	LOS	Volume	LOS
US 101	N-S	N. of Clark Ave	Freeway	4 (divided)	2017	45,500	B	65,900	D	64,670	D	66,180	D
US 101	N-S	S. of Clark Ave	Freeway	4 (divided)	2019	35,800	B	45,870	B	45,770	B	46,070	B
US 101	N-S	N. of Santa Maria Wy Junction	Freeway	6 (divided)	2017	57,000	B	112,010	F	105,460	E	111,530	F
US 101	N-S	S. of Santa Maria Wy Junction	Freeway	4 (divided)	2017	59,000	C	92,440	F	90,110	F	92,690	F
US 101	N-S	N. of Betteravia Rd	Freeway	6 (divided)	2017	68,000	B	117,820	F	112,700	F	115,900	F
US 101	N-S	S. of Betteravia Rd	Freeway	6 (divided)	2017	57,000	B	112,010	F	105,460	E	111,530	F
US 101	N-S	N. of Stowell Rd	Freeway	6 (divided)	2017	74,000	B	126,900	F	128,020	F	128,560	F
US 101	N-S	S. of Stowell Rd	Freeway	6 (divided)	2017	68,000	B	134,540	F	125,860	F	132,400	F
US 101	N-S	N. of SR 166 (Main St)	Freeway	6 (divided)	2017	70,000	B	171,210	F	160,430	F	171,370	F
US 101	N-S	S. of SR 166 (Main St)	Freeway	6 (divided)	2017	74,000	B	157,770	F	156,530	F	161,910	F
US 101	N-S	N. of SR 135 (Broadway)	Freeway	6 (divided)	2019	82,090	C	208,810	F	198,890	F	212,870	F
US 101	N-S	S. of SR 135 (Broadway)	Freeway	6 (divided)	2017	67,000	B	170,420	F	160,720	F	170,080	F
Orcutt Expressway (SR 135)	N-S	N. of Clark Ave	Arterial	4 (divided)	2017	29,500	C	32,780	D	33,500	D	33,430	D
Orcutt Expressway (SR 135)	N-S	S. of Clark Ave	Arterial	4 (divided)	2017	20,100	A	23,830	A	24,280	B	23,440	A
Orcutt Expressway (SR 135)	N-S	N. of Foster Rd	Arterial	4 (divided)	2017	37,000	E	74,250	F	76,290	F	76,030	F
Orcutt Expressway (SR 135)	N-S	S. of Foster Rd	Arterial	4 (divided)	2017	24,600	B	37,560	E	39,830	E	39,410	E
Orcutt Expressway (SR 135)	N-S	N. of Lakeview Rd	Arterial	4 (divided)	2017	32,000	D	50,670	F	51,870	F	52,020	F
Orcutt Expressway (SR 135)	N-S	N. of Miller St	Arterial	4 (divided)	2017	43,000	F	51,970	F	52,410	F	52,010	F
Orcutt Expressway (SR 135)	N-S	S. of Miller St	Arterial	4 (divided)	2017	37,500	E	54,660	F	56,140	F	56,300	F
Orcutt Expressway (SR 135)	N-S	N. of Santa Maria Way	Arterial	4 (divided)	2017	41,000	F	62,490	F	63,190	F	63,410	F
Orcutt Expressway (SR 135)	N-S	S. of Santa Maria Way	Arterial	4 (divided)	2017	44,500	F	53,580	F	54,020	F	53,630	F
Broadway (SR 135)	N-S	N. of Betteravia Rd	Primary Arterial	6 (divided)	2017	47,000	F	63,180	F	63,780	F	64,860	F
Broadway (SR 135)	N-S	S. of Betteravia Rd	Primary Arterial	6 (divided)	2017	47,500	F	75,850	F	76,170	F	78,580	F
Broadway (SR 135)	N-S	N. of Stowell Rd	Arterial	4 (divided)	2017	40,500	F	56,570	F	54,670	F	58,770	F
Broadway (SR 135)	N-S	S. of Stowell Rd	Arterial	4 (divided)	2017	44,500	F	71,920	F	72,980	F	76,820	F
Broadway (SR 135)	N-S	N. of Main St	Arterial	4 (divided)	2017	28,500	C	44,400	F	42,510	F	45,730	F
Broadway (SR 135)	N-S	S. of Main St	Arterial	4 (divided)	2017	26,500	B	38,860	E	37,730	E	41,100	F
Broadway (SR 135)	N-S	N. of Donovan Rd	Arterial	4 (divided)	2017	27,000	B	48,860	F	48,360	F	51,900	F
Broadway (SR 135)	N-S	S. of Donovan Rd	Arterial	4 (divided)	2017	27,500	B	40,890	F	39,980	F	42,780	F
Broadway (SR 135)	N-S	W. of US 101	Arterial	4	2017	23,900	A	55,520	F	54,930	F	58,620	F
Main St (SR 166)	E-W	W. of Blosser Rd	Arterial	2 (TWLTL)	2018	14,200	C	23,700	F	22,180	F	23,320	F
Main St (SR 166)	E-W	E. of Blosser Rd	Arterial	4 (TWLTL)	2018	15,900	A	22,910	A	23,180	A	23,920	B
Main St (SR 166)	E-W	E. of Suey Rd	Arterial	4 (TWLTL)	2015	6,400	A	29,430	C	7,370	A	19,150	A
Main St (SR 166)	E-W	W. of Suey Rd	Arterial	4 (TWLTL)	2018	8,700	A	29,260	C	10,250	A	18,830	A
Main St (SR 166)	E-W	US 101 SB-Off Ramp	Arterial	2	2018	29,500	F	39,250	F	40,280	F	40,850	F
Main St (SR 166)	E-W	E. of Broadway (SR 135)	Arterial	4 (divided)	2018	26,500	B	32,970	D	30,700	C	32,800	D
Main St (SR 166)	E-W	W. of Broadway (SR 135)	Arterial	4 (divided)	2018	18,800	A	25,720	B	23,280	A	25,020	B
A St	N-S	S. of Betteravia Dr	Secondary Arterial	2 (TWLTL)	2015	3,450	A	4,120	A	4,850	A	4,590	A
A St	N-S	S. of Sonya Ln	Secondary Arterial	2	2019	3,650	A	5,690	A	10,420	A	9,410	A
Alvin Ave	E-W	W. of Railroad Ave	Secondary Arterial	4	2018	8,510	A	9,620	A	9,180	A	10,000	A
Alvin Ave	E-W	W. of College Dr	Secondary Arterial	4	2018	7,700	A	15,620	A	12,850	A	14,730	A
Alvin Ave	E-W	E. of Bradley Rd	Secondary Arterial	4	2018	6,670	A	14,550	A	11,720	A	13,640	A
Alvin Ave	E-W	W. of Suey Rd	Secondary Arterial	4	2018	3,440	A	9,760	A	7,050	A	8,670	A
Battles Rd	E-W	E. of Blosser Rd	Secondary Arterial	4	2018	10,740	A	13,690	A	15,610	A	15,810	A
Battles Rd	E-W	W. of Blosser Rd	Secondary Arterial	4	2018	9,320	A	10,370	A	14,400	A	14,140	A
Battles Rd	E-W	W. of Bradley Rd	Secondary Arterial	4	2018	7,670	A	17,170	A	28,320	C	28,470	C

City of Santa Maria Roadway Inventory													
Characteristics					Existing			2050 Annex		2050 Infill		2050 Hybrid	
Road	Direction	Location	Facility Type	Lanes	Year	Volume	LOS	Volume	LOS	Volume	LOS	Volume	LOS
Battles Rd	E-W	E. of Broadway (SR 135)	Secondary Arterial	4	2015	13,220	A	16,540	A	17,580	A	18,190	A
Battles Rd	E-W	W. of Broadway (SR 135)	Secondary Arterial	4	2019	11,650	A	12,700	A	13,680	A	14,120	A
Bay Ave	N-S	b/w Donovan Rd and Harding Ave	Local	2	2015	3,490	A	3,490	A	3,490	A	3,490	A
Betteravia Dr	E-S	E. of A St	Primary Arterial	4 (divided)	2018	14,630	A	20,500	A	36,120	E	33,830	D
Betteravia Dr	E-S	E. of Skyway Dr	Primary Arterial	4 (divided)	2018	15,390	A	26,920	B	35,200	D	34,600	D
Betteravia Dr	E-W	E. of Bradley Dr	Primary Arterial	6 (divided)	2018	38,460	E	55,320	F	56,990	F	57,830	F
Betteravia Dr	E-W	W. of College Dr	Primary Arterial	6 (divided)	2018	34,170	D	62,130	F	61,000	F	65,080	F
Betteravia Dr	E-W	W. of Depot St	Primary Arterial	4 (TWLTL)	2018	20,620	A	39,440	E	45,310	F	45,130	F
Betteravia Dr	E-W	E. of Broadway (SR 135)	Primary Arterial	6 (divided)	2018	30,350	C	48,580	F	49,690	F	51,440	F
Blosser Rd	N-S	S. of Foster Rd	Secondary Arterial	2	2015	2,220	A	42,130	F	41,530	F	41,570	F
Blosser Rd	N-S	S. of Stowell Rd	Secondary Arterial	4 (TWLTL)	2018	24,120	B	41,890	F	47,450	F	48,930	F
Blosser Rd	N-S	b/w Boone St and Cook St	Secondary Arterial	4 (TWLTL)	2018	23,530	A	31,860	C	39,390	E	40,390	F
Blosser Rd	N-S	S. of Main St (SR 166)	Secondary Arterial	4	2015	24,960	B	33,480	D	40,160	F	40,990	F
Blosser Rd	N-S	S. of Alvin Ave	Secondary Arterial	4	2019	14,140	A	23,250	A	25,260	B	26,580	B
Blosser Rd	N-S	S. of Donovan Rd	Secondary Arterial	4	2018	15,200	A	23,770	A	25,180	B	26,000	B
Blosser Rd	N-S	N. of Taylor St	Secondary Arterial	2	2015	5,120	A	5,930	A	6,000	A	6,360	A
Blosser Rd	N-S	S. of Taylor St	Secondary Arterial	4	2018	7,970	A	13,010	A	13,390	A	14,500	A
Blosser Rd	N-S	N. of Canal St	Secondary Arterial	2	2018	2,700	A	2,610	A	2,690	A	2,790	A
Bradley Rd	N-S	S. of Cottage Ln	Secondary Arterial	4 (TWLTL)	2018	1,000	A	5,030	A	4,430	A	5,250	A
Bradley Rd	N-S	S. of Bello Rd	Secondary Arterial	4 (TWLTL)	2019	4,960	A	6,360	A	5,800	A	6,200	A
Bradley Rd	N-S	S. of Betteravia Dr	Secondary Arterial	4	2018	22,740	A	27,410	B	26,700	B	27,330	B
Bradley Rd	N-S	N. of Battles Rd	Secondary Arterial	4 (TWLTL)	2018	16,420	A	33,360	D	39,770	E	42,140	F
Bradley Rd	N-S	S. of Battles Rd	Secondary Arterial	4 (TWLTL)	2018	10,760	A	18,410	A	13,460	A	15,670	A
Bradley Rd	N-S	N. of Stowell Rd	Secondary Arterial	2	2018	14,860	F	18,170	F	17,610	F	18,730	F
Bradley Rd	N-S	b/w SR 101 SB-On Ramp and Cypress St (one-way)	Secondary Arterial	2	2018	3,750	A	7,830	B	3,940	A	6,590	A
Bradley Rd	E-W	E. of College Dr	Secondary Arterial	2	2015	3,950	A	3,950	A	3,950	A	3,950	A
Bull Canyon Rd	N-S	N. of Panther Dr	Collector	2	2018	260	A	2,510	A	1,640	A	2,870	A
California Blvd	N-S	S. of Foster Rd	Local	2	2015	1,460	A	1,840	A	1,790	A	1,810	A
Camino Colegio	E-W	E. of Miller St	Local	2	2015	1,280	A	1,460	A	1,580	A	1,580	A
Camino Colegio	E-W	W. of Miller St	Local	2	2015	1,400	A	1,500	A	1,490	A	1,580	A
Canal St	E-W	E. of Blosser Rd	Collector	2	2019	1,140	A	1,910	A	1,900	A	2,050	A
Carlotti Dr	N-S	b/w Noble Wy and Paden St	Collector	2	2015	5,490	A	19,590	F	20,070	F	19,740	F
Carlotti Dr	N-S	b/w Stanford Dr and Murray Dr	Collector	2	2015	3,700	A	19,380	F	19,780	F	19,470	F
Carmen Ln	E-W	W. of Thornburg St	Collector	2	2015	5,440	A	4,000	A	4,080	A	4,190	A
Carmen Ln	E-W	W. of Broadway (SR 135)	Collector	2	2015	7,580	A	8,630	A	8,420	A	8,630	A
Centennial St	N-S	b/w Mt Whitney Wy and Panther Dr	Collector (proposed)	2	2015	1,480	A	1,480	A	1,480	A	1,480	A
Cesar E Chavez Dr	N-S	S. of Hidden Pines Wy	Collector	2	2013	3,390	A	3,450	A	3,480	A	3,450	A
College Dr	N-S	E. of Santa Maria Wy	Secondary Arterial	4 (divided)	2019	9,730	A	25,870	B	25,050	B	25,680	B
College Dr	N-S	N. of McCoy Ln (Roundabout)	Secondary Arterial	4	2015	11,240	A	14,080	A	14,250	A	14,320	A
College Dr	N-S	S. of McCoy Ln (Roundabout)	Secondary Arterial	4	2019	8,230	A	17,690	A	18,690	A	18,960	A

City of Santa Maria Roadway Inventory													
Characteristics				Existing				2050 Annex		2050 Infill		2050 Hybrid	
Road	Direction	Location	Facility Type	Lanes	Year	Volume	LOS	Volume	LOS	Volume	LOS	Volume	LOS
College Dr	N-S	S. of Sunrise Dr	Secondary Arterial	4 (divided)	2018	10,960	A	21,210	A	21,600	A	22,260	A
College Dr	N-S	N. of Betteravia Dr	Secondary Arterial	4 (divided)	2019	9,300	A	23,380	A	24,760	B	28,040	C
College Dr	N-S	S. of Betteravia Dr	Secondary Arterial	4 (divided)	2018	10,840	A	14,070	A	14,150	A	14,220	A
College Dr	N-S	N. of Battles Rd	Secondary Arterial	4 (divided)	2018	10,760	A	24,600	B	25,480	B	28,330	C
College Dr	N-S	N. of Stowell Rd	Secondary Arterial	4 (TWLTL)	2018	12,310	A	31,400	C	30,170	C	33,430	D
College Dr	N-S	N. of Boone St/Jones St	Secondary Arterial	2	2019	9,610	A	34,140	F	31,920	F	36,370	F
College Dr	N-S	S. of Boone St/Jones St	Secondary Arterial	2	2015	9,930	A	29,480	F	29,140	F	33,150	F
College Dr	N-S	N. of Main (SR 166)	Secondary Arterial	4 (TWLTL)	2019	8,620	A	20,780	A	18,820	A	21,930	A
College Dr	N-S	N. of Alvin Ave	Secondary Arterial	4	2015	5,820	A	12,940	A	12,540	A	13,930	A
College Dr	N-S	S. of Donovan Rd	Secondary Arterial	4	2018	8,020	A	14,230	A	13,810	A	15,100	A
Concepcion Ave	N-S	N. of Jones St	Collector	2	2018	970	A	920	A	1,140	A	920	A
Cook St	E-W	W. of Depot St	Collector	2	2018	6,190	A	6,800	A	7,100	A	7,300	A
Cook St	E-W	W. of Broadway (SR 135)	Collector	4 (divided)	2017	8,870	A	11,090	A	12,190	A	12,420	A
Cook St	E-W	E. of Broadway (SR 135)	Collector	4 (divided)	2018	8,990	A	11,550	A	11,810	A	11,610	A
Cook St	E-W	b/w Miller St and School St	Collector	2	2015	3,150	A	6,090	A	6,170	A	6,310	A
Cook St	E-W	b/w East Ave and College Dr	Collector	2	2015	2,190	A	4,700	A	4,740	A	4,850	A
Crossroad Ln	E-W	W. of Bradley Rd	Collector	2	2018	4,800	A	7,570	A	7,650	A	7,990	A
Depot St	N-S	N. of Carmen Ln	Secondary Arterial	4	2015	4,500	A	6,020	A	5,870	A	6,420	A
Depot St	N-S	N. of Battles Rd	Secondary Arterial	2	2018	10,450	B	9,070	A	8,610	A	9,880	B
Depot St	N-S	N. of Stowell Rd	Secondary Arterial	4	2018	9,560	A	16,660	A	20,860	A	21,560	A
Depot St	N-S	N. of Main (SR 166)	Secondary Arterial	2	2018	8,940	A	10,740	A	10,620	A	10,960	A
Depot St	N-S	S. of Cook St	Secondary Arterial	2	2018	8,280	A	19,830	E	22,370	F	23,660	F
Donovan Rd	E-W	W. of Railroad Ave	Secondary Arterial	4	2018	11,580	A	14,490	A	16,130	A	15,970	A
Donovan Rd	E-W	W. of Broadway (SR 135)	Secondary Arterial	4	2015	17,390	A	26,280	B	26,540	B	28,230	C
Donovan Rd	E-W	E. of Broadway (SR 135)	Secondary Arterial	4	2018	16,580	A	18,050	A	17,090	A	17,780	A
Donovan Rd	E-W	W. of College Dr	Secondary Arterial	4 (divided)	2019	19,010	A	21,760	A	20,660	A	22,350	A
Donovan Rd	E-W	E. of College Dr	Secondary Arterial	4 (divided)	2018	23,900	A	29,430	C	28,520	C	30,080	C
Donovan Rd	E-W	W. of Carlotti Dr	Secondary Arterial	4	2018	23,040	A	34,270	D	33,560	D	34,920	D
Donovan Rd	E-W	W. of Suey Rd	Secondary Arterial	4	2018	7,530	A	8,980	A	7,650	A	9,190	A
Enos Dr	E-W	E. of College Dr	Collector	2	2015	2,850	A	3,590	A	3,030	A	3,180	A
Fairway Dr	E-W	E. of A St	Collector	2	2015	2,700	A	3,740	A	4,040	A	3,920	A
Fairway Dr	E-W	E. of Skyway Dr	Collector	2	2015	3,490	A	5,540	A	5,230	A	5,670	A
Farrell Dr	N-S	N. of Jones St	Local	2	2018	2,740	A	2,750	A	2,740	A	2,750	A
Fesler St	E-W	E. of Broadway (SR 135)	Secondary Arterial	4	2018	5,640	A	11,950	A	10,980	A	11,870	A
Fesler St	E-W	W. of Broadway (SR 135)	Secondary Arterial	4	2015	6,880	A	12,230	A	13,730	A	13,590	A
Fesler St	E-W	b/w Benwiley Ave and Railroad Ave	Secondary Arterial	2	2018	3,800	A	4,680	A	4,930	A	4,890	A
Foster Rd	E-W	W. of Orcutt Expressway (SR 135)	Collector	2	2019	4,190	A	30,930	F	31,700	F	31,470	F
Foxenwood Ln	N-S	S. of Foster Rd	Collector	2	2015	810	A	930	A	890	A	880	A
Grant St	E-W	b/w Broadway (SR 135) and River Ranch Dr	Collector	2	2015	5,230	A	5,460	A	5,360	A	5,230	A
Hidden Pines Wy	E-W	W. of Preisker Ln	Collector	2	2015	7,950	A	8,730	A	8,670	A	8,770	A
Industrial Pkwy	N-S	E. of Skyway Dr	Collector	2 (TWLTL)	2019	1,870	A	3,920	A	3,610	A	4,050	A
La Brea Ave	E-W	W. of Blosser Rd	Collector	2	2015	1,910	A	2,730	A	10,300	B	10,320	B
Lynne Dr	N-S	b/w Lee Dr and Donovan Rd	Collector	2	2015	5,670	A	6,040	A	6,050	A	6,360	A

City of Santa Maria Roadway Inventory													
Characteristics					Existing			2050 Annex		2050 Infill		2050 Hybrid	
Road	Direction	Location	Facility Type	Lanes	Year	Volume	LOS	Volume	LOS	Volume	LOS	Volume	LOS
Jones St	E-W	E. of Farrell Dr	Collector	2	2018	7,990	A	22,970	F	13,750	D	20,820	F
Jones St	E-W	W. of Bradley Rd	Collector	2	2018	4,400	A	19,400	F	10,170	B	17,250	F
McClelland St	N-S	S. of Cook St	Collector	2	2015	3,330	A	4,000	A	3,960	A	4,270	A
McCoy Ln	E-W	E. of A St	Secondary Arterial	2		2,880	A	3,010	A	3,330	A	3,320	A
McCoy Ln	E-W	E. of Skyway Dr	Secondary Arterial	4 (TWLTL)	2018	11,850	A	15,240	A	16,170	A	16,300	A
McCoy Ln	E-W	E. of Broadway (SR 135)	Secondary Arterial	4 (divided)	2018	12,760	A	18,000	A	18,520	A	18,860	A
McCoy Ln	E-W	W. of Broadway (SR 135)	Secondary Arterial	4 (divided)	2019	14,960	A	19,200	A	20,500	A	20,530	A
McCoy Ln	E-W	E. of College Dr (roundabout)	Secondary Arterial	4	2015	5,330	A	5,400	A	5,370	A	5,410	A
McCoy Ln	E-W	W. of College Dr (roundabout)	Secondary Arterial	4	2019	6,380	A	12,350	A	13,320	A	13,680	A
Miller St	N-S	N. of Battles Rd	Secondary Arterial	4 (divided)	2018	14,540	A	26,250	B	27,520	B	28,780	C
Miller St	N-S	N. of Stowell Rd	Secondary Arterial	2	2018	13,420	B	19,720	E	19,250	E	20,450	F
Miller St	N-S	S. of Main (SR 166)	Secondary Arterial	4 (divided)	2017	14,770	A	21,780	A	22,090	A	23,260	A
Miller St	N-S	S. of Alvin Ave	Secondary Arterial	2	2015	8,520	A	11,140	A	11,070	A	11,460	A
Miller St	N-S	b/w Lee Dr and Donovan Rd	Secondary Arterial	2	2015	4,160	A	5,640	A	5,500	A	5,890	A
Miller St	N-S	S. of Donovan Rd	Secondary Arterial	4	2018	5,840	A	8,170	A	7,880	A	8,570	A
Miller St	E-W	E. of Santa Maria Wy	Secondary Arterial	4 (divided)	2018	11,120	A	23,190	A	23,890	A	24,070	B
Miller St	N-S	S. of Betteravia Dr	Secondary Arterial	4 (divided)	2018	13,990	A	27,980	C	28,100	C	28,630	C
Morrison Ave	E-W	W. of Broadway (SR 135)	Collector	2	2015	5,140	A	6,430	A	6,830	A	6,310	A
Morrison Ave	E-W	W. of Depot St	Collector	2	2018	5,500	A	6,150	A	5,960	A	6,110	A
Palisade Dr	N-S	S. of Main (SR 166)	Local	2	2018	7,440	B	8,340	C	7,810	B	8,070	B
Panther Dr	N-S	S. of Suey Crossing Rd	Secondary Arterial	4	2015	4,810	A	6,250	A	5,720	A	6,040	A
Preisker Ln	N-S	N. of Broadway (SR 135)	Collector	2	2018	10,880	B	11,950	C	11,820	C	11,970	C
Professional Pkwy	N-S	N. of McCoy Ln	Collector	2	2015	2,760	A	3,150	A	3,150	A	3,180	A
Railroad Ave	N-S	N. of Fesler Ave	Secondary Arterial	2 (TWLTL)	2019	8,750	A	11,410	A	11,390	A	11,700	A
Railroad Ave	N-S	b/w Donovan Rd and Harding Ave	Secondary Arterial	2	2018	9,980	A	12,050	B	12,080	B	12,340	B
Railroad Ave	N-S	N. of Taylor St	Secondary Arterial	2	2015	6,160	A	10,240	A	9,880	A	10,600	A
Railroad Ave	N-S	S. of Taylor St	Secondary Arterial	2	2015	7,780	A	12,270	B	12,000	A	12,970	B
Santa Maria Wy	N-S	S. of Miller Wy	Secondary Arterial	4 (divided)	2017	10,470	A	21,810	A	22,050	A	22,900	A
Santa Maria Wy	N-S	S. of Dauphin St	Secondary Arterial	4 (divided)	2018	10,420	A	22,890	A	22,710	A	24,910	B
Shepard Dr	N-S	N. of Battles Rd	Collector	2	2015	1,900	A	2,860	A	2,640	A	3,260	A
Sierra Madre Ave	E-W	W. of Bradley Rd	Collector	2	2015	1,350	A	4,880	A	3,250	A	4,020	A
Skyway Dr	N-S	S. of Industrial Pkwy	Secondary Arterial	4 (divided)	2015	15,740	A	28,790	C	31,530	C	31,200	C
Skyway Dr	E-S	W. of Orcutt Expressway (SR 135)	Secondary Arterial	4 (divided)	2018	17,350	A	31,070	C	33,180	D	32,510	D
Skyway Dr	N-S	N. of Fairway Dr	Secondary Arterial	4 (divided)	2019	16,540	A	30,900	C	32,550	D	32,960	D
Skyway Dr	N-S	S. of Fairway Dr	Secondary Arterial	4 (divided)	2019	15,260	A	27,940	C	30,570	C	30,430	C
Skyway Dr	N-S	N. of Betteravia Dr	Secondary Arterial	4 (divided)	2018	20,010	A	35,450	D	33,650	D	34,880	D
Skyway Dr	N-S	S. of Betteravia Dr	Secondary Arterial	4 (divided)	2018	19,530	A	31,040	C	32,120	D	32,460	D
Sonya Ln	E-W	E. of A St	Collector	2	2015	360	A	750	A	940	A	890	A
Southside Pkwy	E-S	E. of Centerpoint Pkwy	Collector	2	2015	1,400	A	1,400	A	1,370	A	1,380	A
Southside Pkwy	E-S	W. of Bradley Rd (Roundabout)	Collector	2	2018	4,940	A	4,940	A	4,940	A	4,940	A
Stowell Rd	E-W	W. of Bradley Rd	Secondary Arterial	4 (TWLTL)	2018	20,220	A	35,320	D	31,660	C	34,600	D
Stowell Rd	E-W	W. of Depot St	Secondary Arterial	4 (TWLTL)	2018	14,020	A	27,360	B	28,530	C	30,490	C

City of Santa Maria Roadway Inventory

City of Santa Maria Roadway Inventory													
Characteristics					Existing			2050 Annex		2050 Infill		2050 Hybrid	
Road	Direction	Location	Facility Type	Lanes	Year	Volume	LOS	Volume	LOS	Volume	LOS	Volume	LOS
Stowell Rd	E-W	W. of Blosser Rd	Secondary Arterial	4 (TWLTL)	2018	9,510	A	27,160	B	21,850	A	24,190	B
Stowell Rd	E-W	W. of Hanson Wy	Secondary Arterial	2	2018	8,020	A	14,560	C	14,210	C	16,460	D
Suey Rd	N-S	N. of Jones St	Secondary Arterial	2	2015	5,300	A	10,740	A	7,590	A	9,510	A
Suey Rd	N-S	N. of Main (SR 166)	Secondary Arterial	2	2018	7,590	A	10,740	A	10,180	A	11,320	A
Suey Rd	N-S	N. of Alvin Ave	Secondary Arterial	4	2019	4,850	A	9,140	A	8,280	A	9,100	A
Sunrise Dr	E-W	W. of College Dr	Collector	2	2015	2,440	A	2,510	A	2,510	A	2,510	A
Sunrise Dr	E-W	E. of Santa Maria Wy	Collector	2	2018	2,910	A	3,160	A	3,160	A	3,160	A
Taylor St	E-W	W. of Railroad Ave	Collector	2	2018	5,740	A	9,190	A	9,470	A	10,080	B
Taylor St	E-W	W. of Broadway (SR 135)	Collector	2	2015	10,930	B	12,130	C	12,340	C	12,890	D
Thornburg St	N-S	N. of Betteravia Dr	Collector	2	2018	6,150	A	6,330	A	6,210	A	6,310	A
Thornburg St	N-S	N. of Carmen Ln	Collector	2	2015	3,710	A	5,080	A	5,090	A	5,500	A
Thornburg St	E-W	S. of Battles Rd	Collector	2	2015	3,590	A	6,020	A	5,740	A	6,360	A
Union Valley Parkway	E-S	W. of Orcutt Expressway (SR 135)	Primary Arterial	4 (divided)	2015	5,990	A	35,670	D	36,410	E	36,490	E
Union Valley Parkway	E-S	E. of Blosser Rd	Primary Arterial	2	2015	1,630	A	29,400	F	30,460	F	29,920	F
Western Ave	N-S	N. of Stowell Rd	Collector	2	2018	8,330	A	9,900	B	9,890	B	10,060	B
Western Ave	N-S	N. of Main (SR 166)	Collector	2	2013	4,290	A	5,250	A	5,260	A	5,410	A
Western Ave	N-S	S. of Main (SR 166)	Collector	2	2019	4,390	A	5,220	A	5,240	A	5,260	A
Westgate Rd	N-S	S. of Battles Rd	Collector	2	2019	3,590	A	3,590	A	3,590	A	3,590	A
Westgate Rd	N-S	N. of Carmen Ln	Collector	2	2015	1,640	A	1,640	A	1,640	A	1,640	A

Attachment 2

Vehicle-to-Capacity Ratio Maps

Alternative: Annex
Time Period: PM Peak Hour

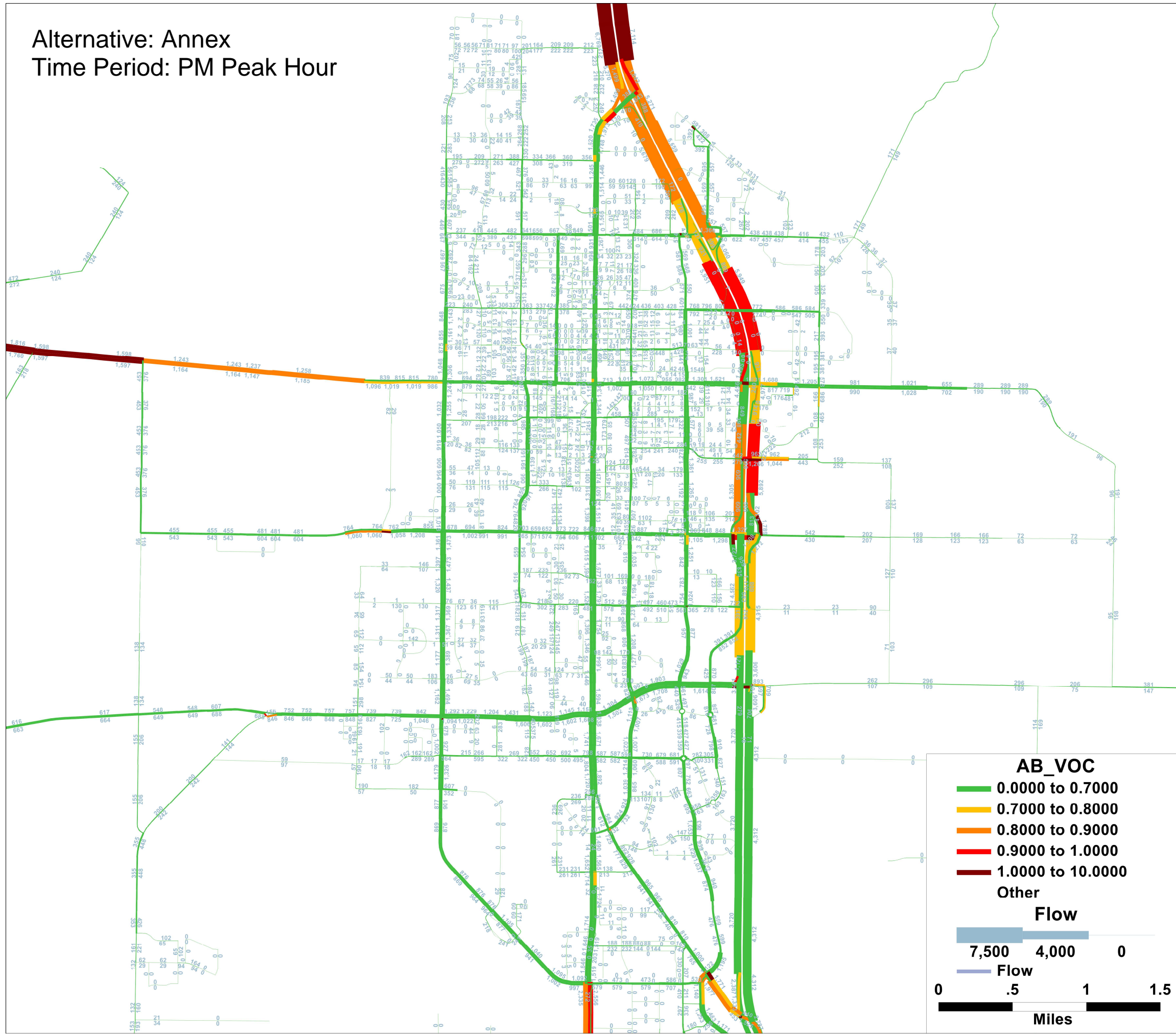

Alternative: Annex Time Period: Daily

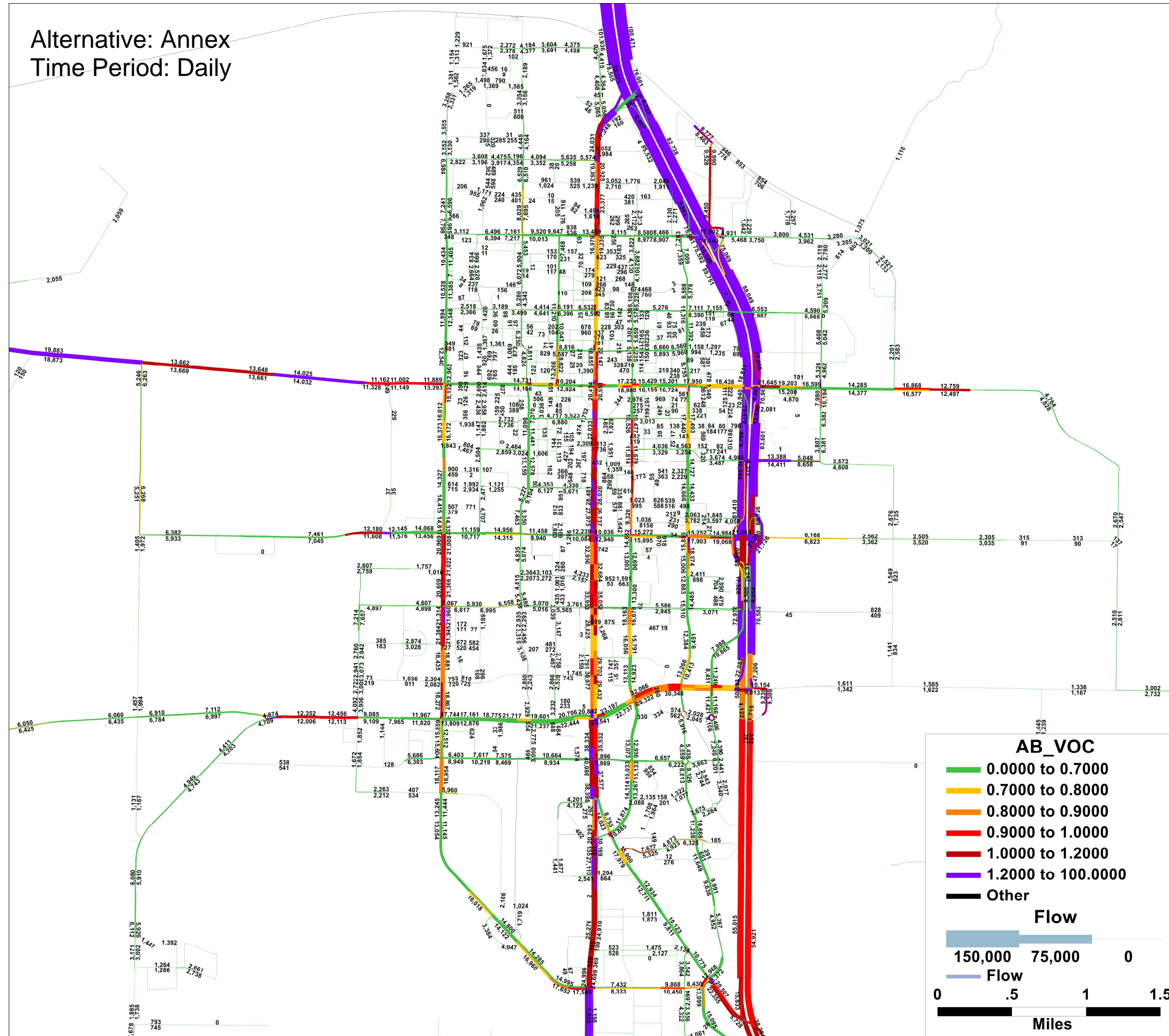

Alternative: Infill
Time Period: PM Peak Hour

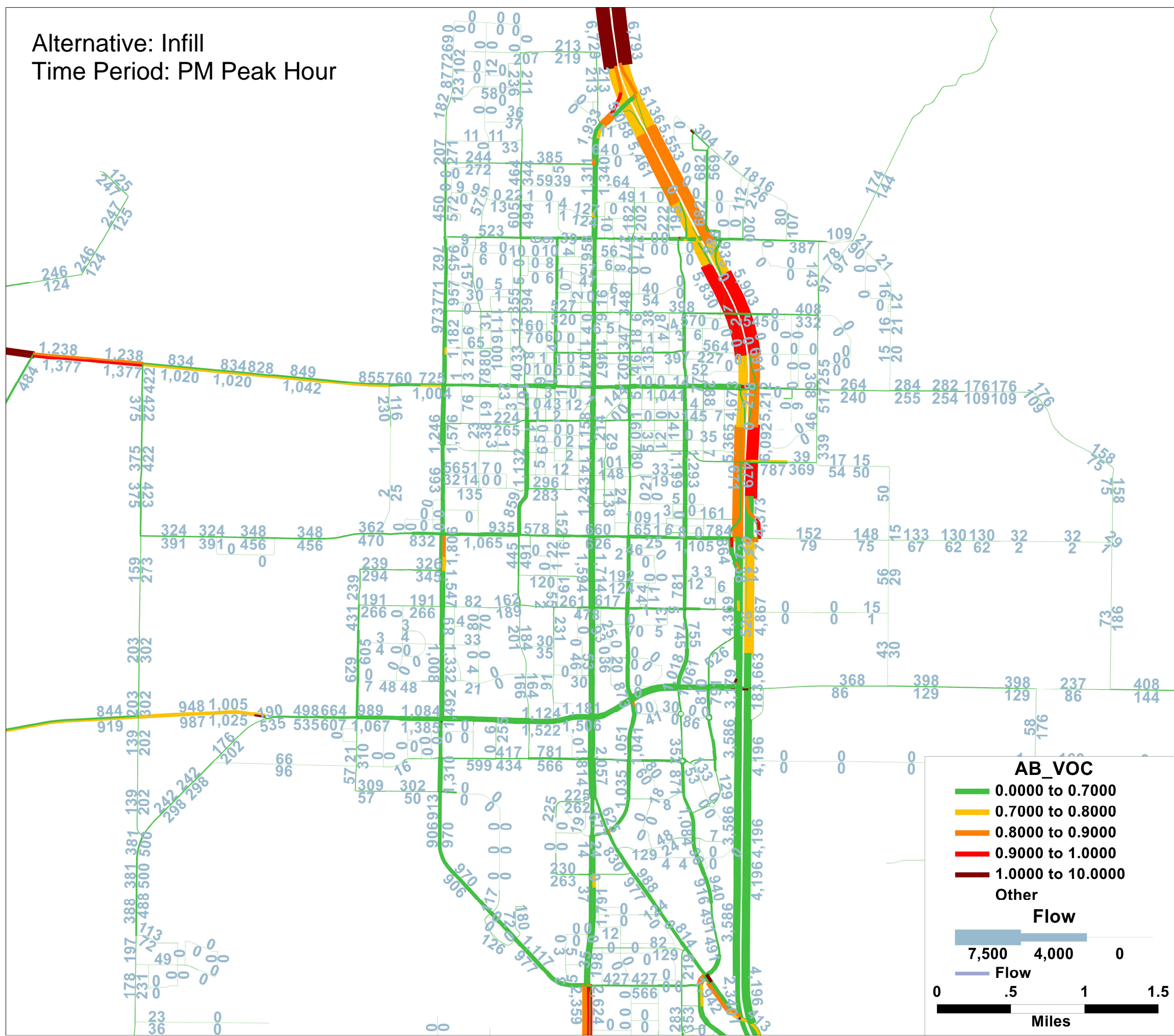

Alternative: Infill Time Period: Daily

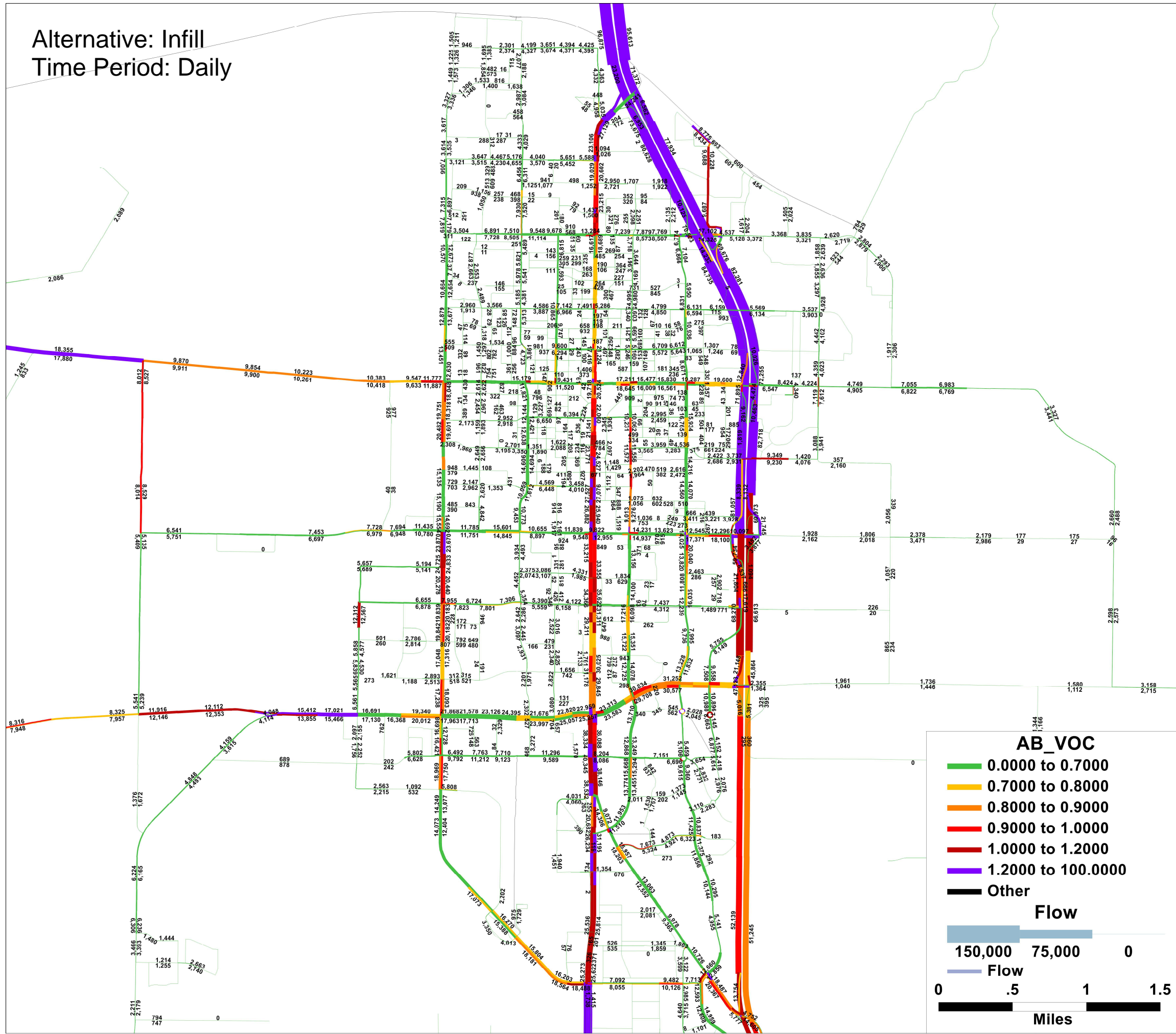

Alternative: Hybrid
Time Period: PM Peak Hour

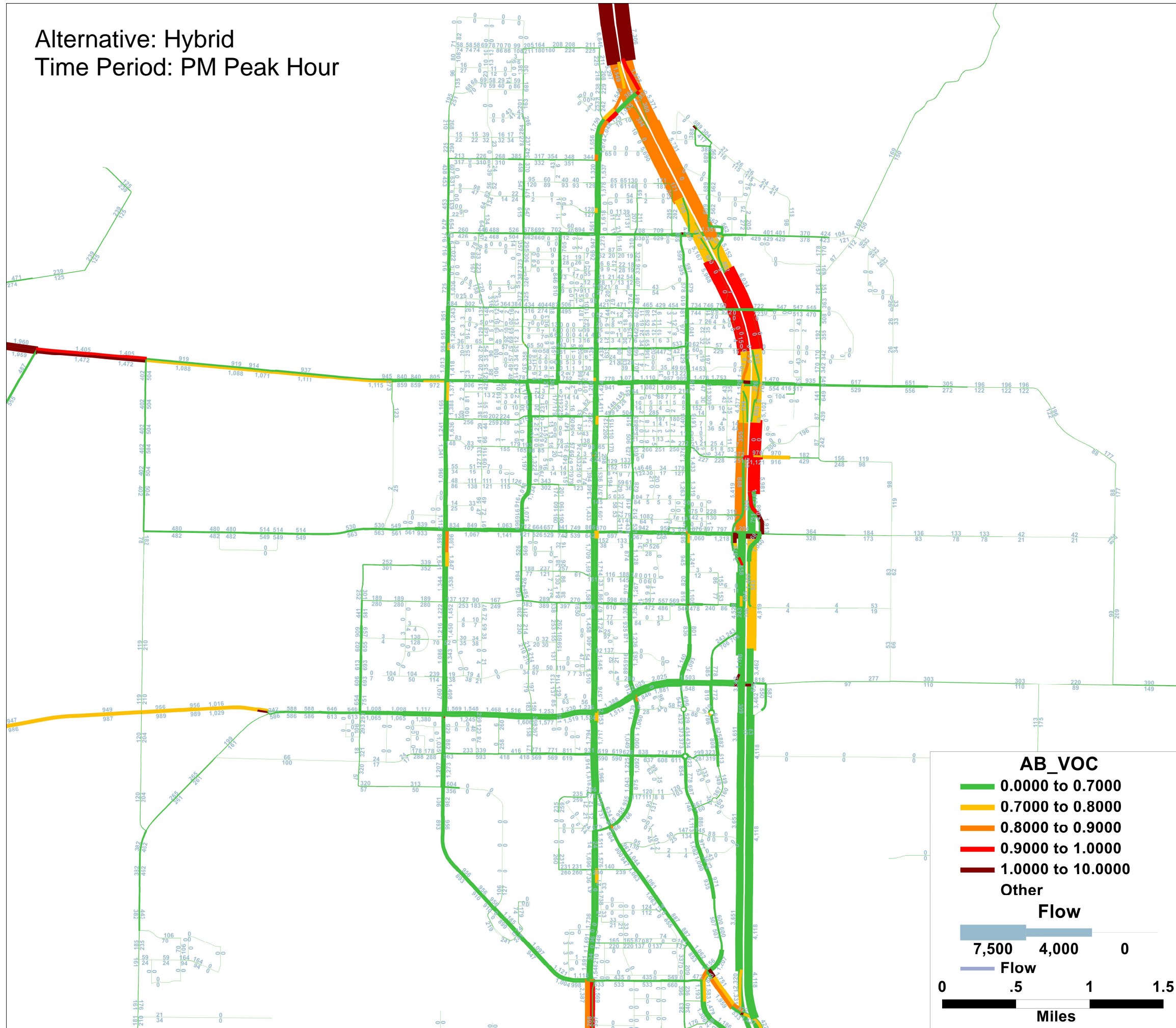

Alternative: Hybrid Time Period: Daily

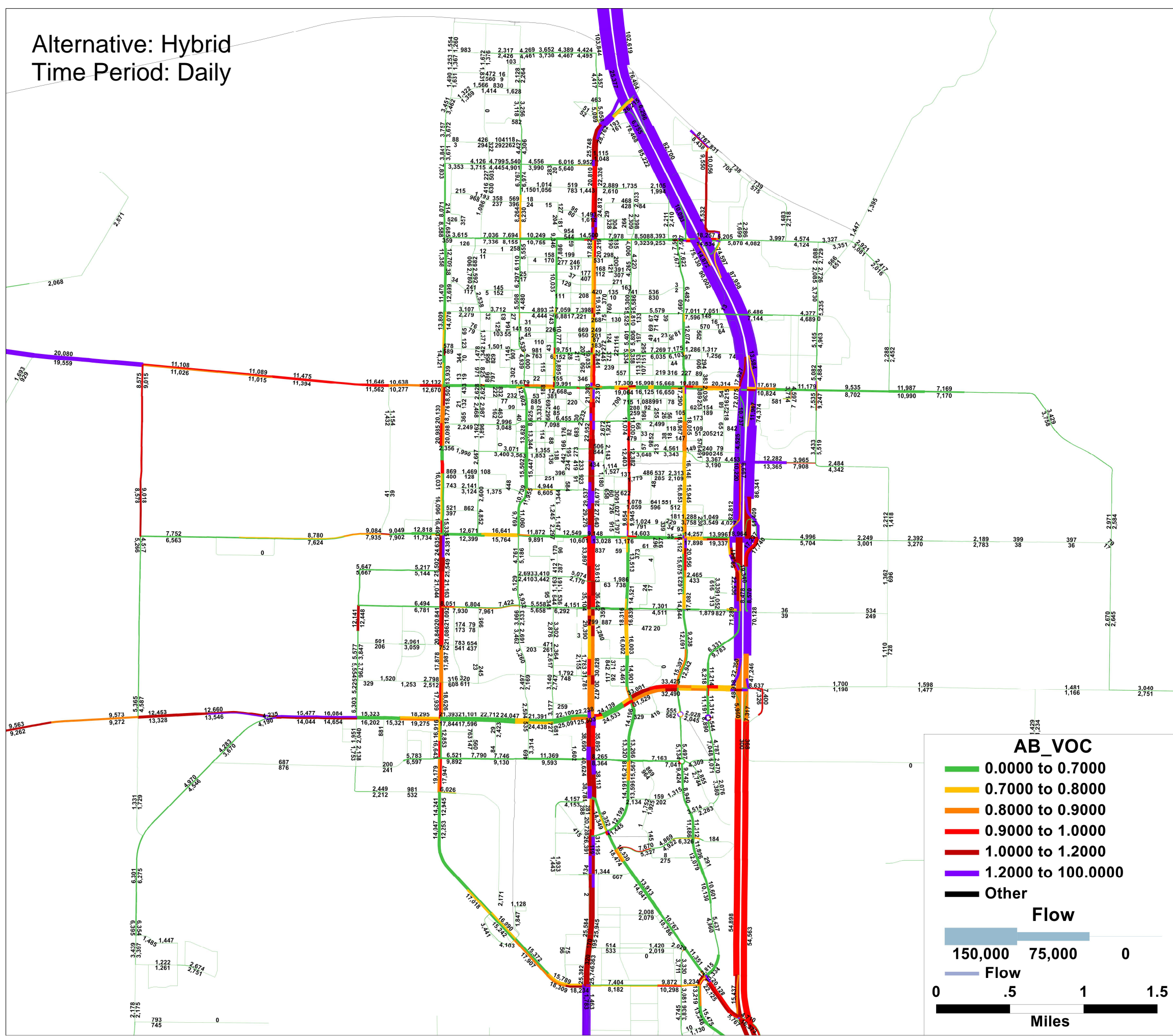

Appendix B: Public Realm Design Options

Santa Maria General Plan Update
Public Realm Design Options

November 18, 2022

SERA

INTRODUCTION & BACKGROUND

Intent

This slide deck introduces a toolkit for enhancing the public realm and urban design in Santa Maria. As such, this toolkit includes items related to both open spaces and streets.

Relationship to Land Use Alternatives

Slide 22 features a matrix that matches tools with General Plan land use designations, which regulate land use, density, and intensity. When considering potential future land use Alternatives, the matrix on slide 22 can be used to identify how different public realm and urban design tools, described in slides 4 through 19, could be applied in different parts of the city. Note, some toolkit items may be recommended in the General Plan regardless of the land use Alternative.

For a closer look at differences in the application of toolkit items by Alternative, slides 23 through 25 geographically illustrate where particular tools would apply in key areas of change, unique to each Alternative.

Relationship to Street Section

Slides 20 and 21 provide examples of how various public realm and urban design tools can be applied on primary and secondary arterials, like Broadway and Main Street, respectively.

Relationship to the Updated General Plan

The updated General Plan will include design guidance to preserve community character, including how public realm and urban design tools are to be applied citywide and by subarea or neighborhood. This toolkit can serve as the basis for the design guidance in the General Plan.

Community Input Needed

To inform the updated General Plan, community input is needed to inform:

- Which tools are appropriate for Santa Maria?
- Are any public realm or design tools missing from the toolkit that would be appropriate for Santa Maria?
- Which features of each tool do you like, and which would you change?
- Which tools are most appropriate in different areas of the city?
- Which tools are appropriate on different streets around the city?

TOOLKIT GLOSSARY

The toolkit includes both open space and street items that are intended to enhance the public realm. This glossary provides an overview of each item.

OPEN SPACES



Natural Open Space
Ecological restoration, recreation, rest



Park
Socialization, recreation, and/or rest



Plaza
Socialization and celebration



Trail
Recreation and/or commuting



Pocket Park
Socialization and/or rest



Food Truck Pod
Public activation and economic dev't

STREETS

Applied in Specific Locations



Gateway
Placemaking and community building



Public Art
Placemaking and community building

Right-of-Way Enhancements



Sidewalk Widening
Enhance public access and commercial frontage



Street Trees
Biophilic experience and shade



Furnishing
Public realm activation and visitor comfort



Landscape Strip
Biophilic experience and pervious surface



Curb Extension
Intent: Safety and placemaking



Alleyway
Public realm activation

Temporary



Slow Street
People-first, safe streets for recreation and socialization



Parklet
Public realm activation and economic dev't

OPEN SPACE TOOLKIT: NATURAL OPEN SPACE



Intent and Description

These areas are intended to preserve open spaces for ecological retention and restoration, as well as offer opportunities for residents to connect with nature. They can range from natural, unmodified lands to areas in need of restoration.

Applicability

Within and surrounding communities, this is often land that is preserved for habitat and ecology. As publicly-accessible areas, they contribute to a community's open space network and offer opportunities for residents to connect with nature.

General Plan Land Use Designations

Conservation Open Space (COS), Planned Annexation (PA)

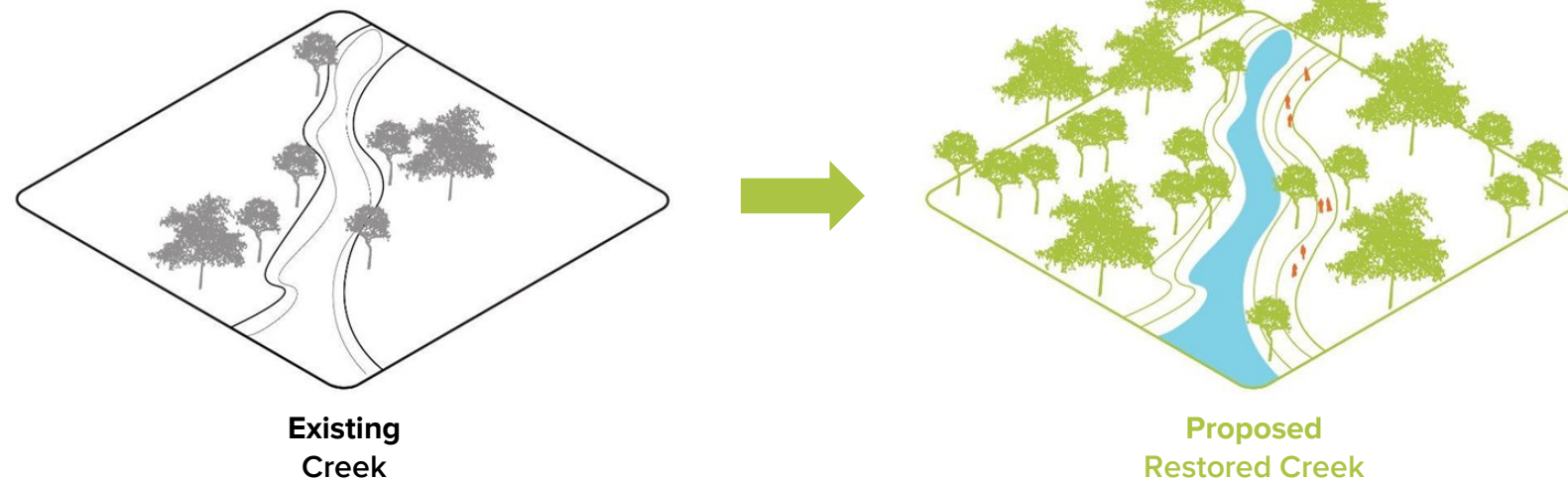

OPEN SPACE TOOLKIT: PARK



Intent and Description

Parks provide residents with places to connect with nature and with others. They typically provide natural features such as lawns, trees, places for recreation and play, as well as other vegetated elements.

Applicability

Parks should generally be greater than an acre and distributed throughout the city so that there is one within a 10-minute walk from each household in Santa Maria.

General Plan Land Use Designations

Primary Agricultural Open Space (AOS-I), Secondary Agricultural Open Space (AOS-II), Conservation Open Space (COS), Recreational Open Space (ROS), Community Facilities (CF), High Density Residential (HDR-35/30), Medium Density Residential (MDR-12), Low Medium Density Residential (LMDR-8), Low Density Residential (LDR-5), Lower-Density Residential (LWDR-4), Broadway Mixed Use (BMU-70/35), Main Street Mixed Use (MMU-70/35), Central District (CD), Light Industrial (LI), Planned Annexation (PA)

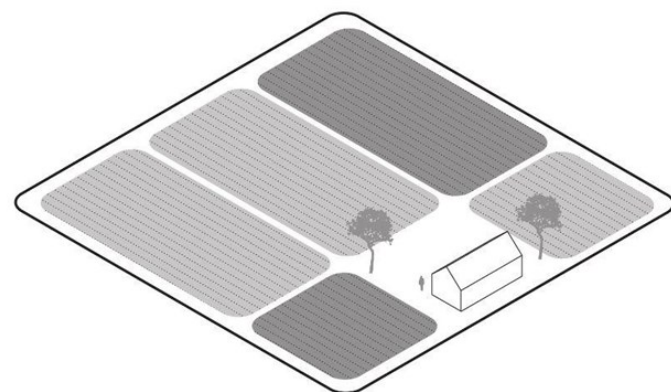

Existing
Agriculture



Proposed
Park



Downtown City Park
Paso Robles, CA

Source: RecWest



Buena Vista Park
Santa Maria, CA

Source: Noozhawk

OPEN SPACE TOOLKIT: PLAZA



Intent and Description

Provide residents and visitors with a centralized place for socialization and celebration. Plazas often feature hardscape surfaces, a central feature such as a stage, fountain, monument or public art, and active building frontages that help to frame the space.

Applicability

For public plazas, there should be no more than one per neighborhood. When publicly built, forecourt plazas of less than one-eighth of an acre are desired in mixed-use developments greater than an acre in scale.

General Plan Land Use Designations

Community Facilities (CF), High Density Residential (HDR-35/30), Medium Density Residential (MDR-12), Low Medium Density Residential (LMDR-8), Broadway Mixed Use (BMU-70/35), Main Street Mixed Use (MMU-70/35), Central District (CD), Specific Plan (SP), Planned Annexation (PA)

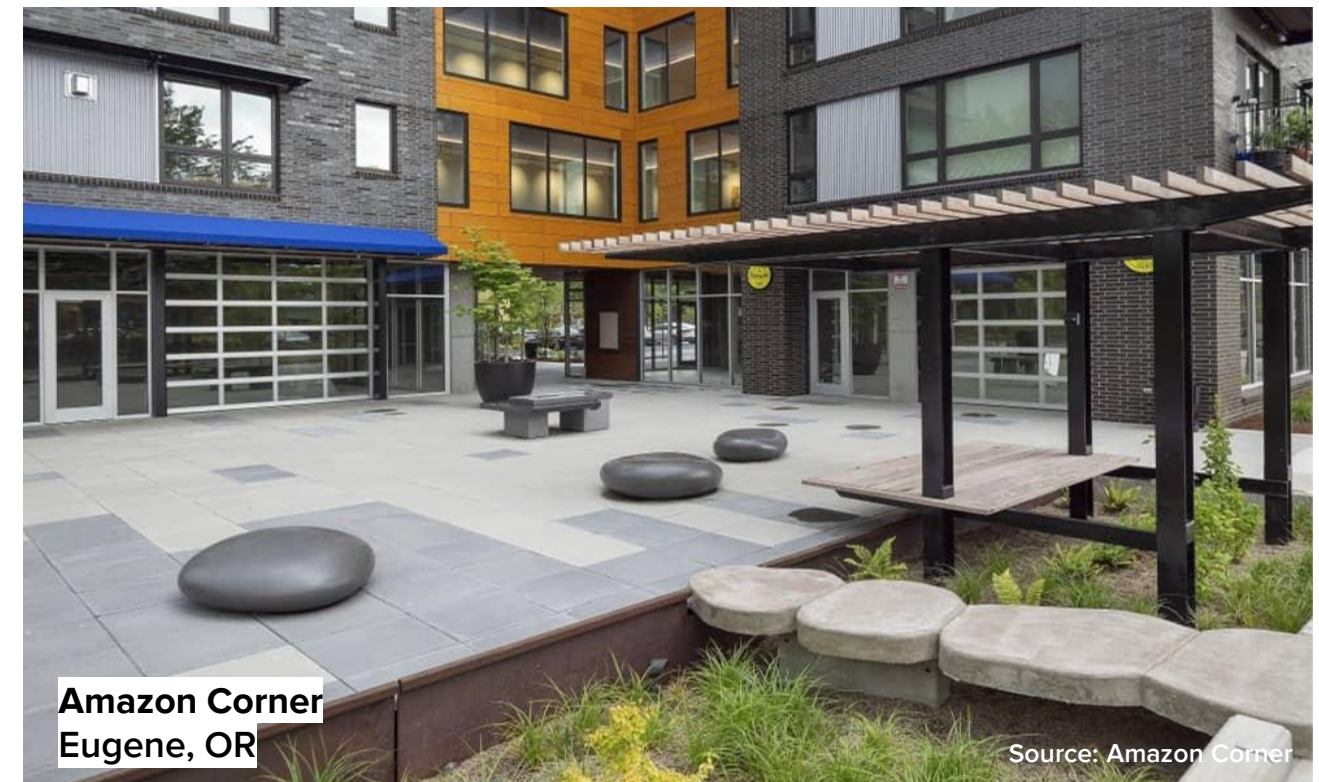
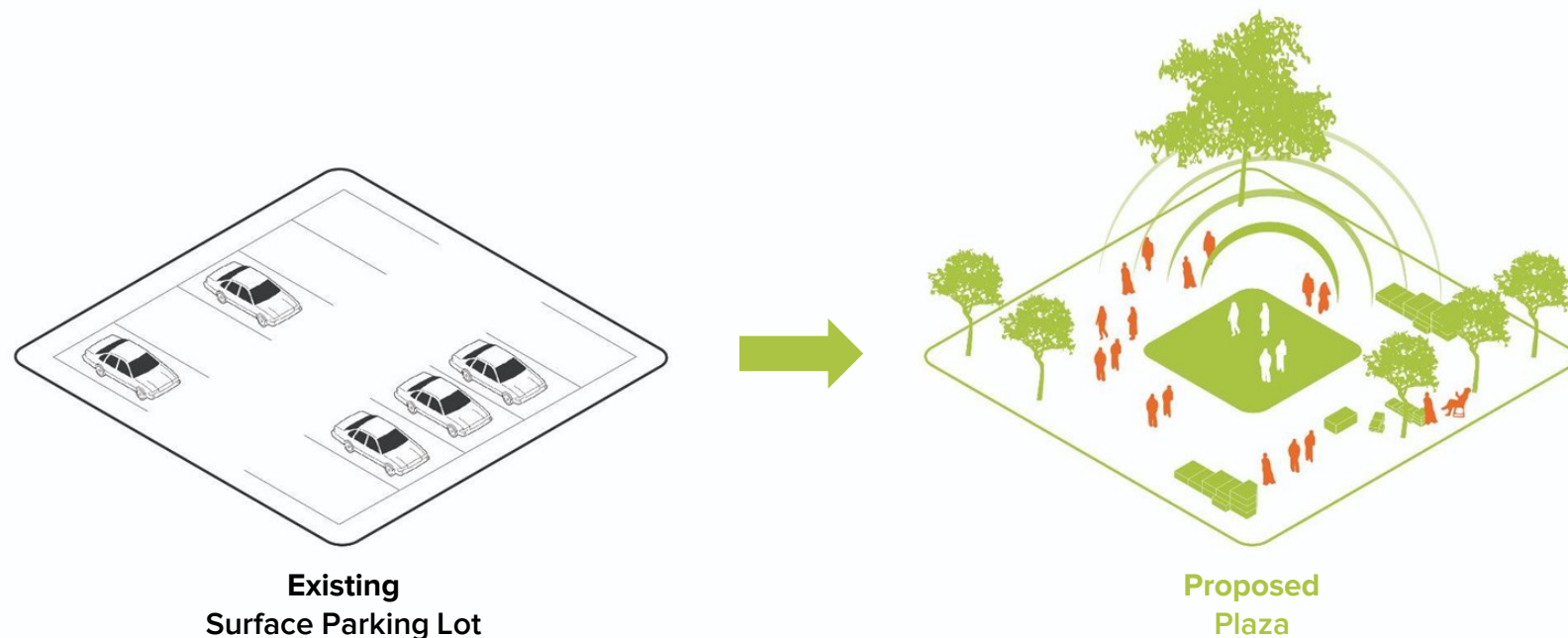

OPEN SPACE TOOLKIT: TRAIL



Intent and Description

Trails offer recreation and commuting opportunities. They should be ADA accessible and wide enough to accommodate a variety of users (pedestrians, cyclists, etc.).

Applicability

Safe and accessible trails should be interconnected to enable connectivity throughout Santa Maria for residents to meet their daily needs.

General Plan Land Use Designations

All designations except for Freeway Services (FS) and Airport Services (AS)



Monterrey Trail
Monterrey, CA

Source: Rails to Trails

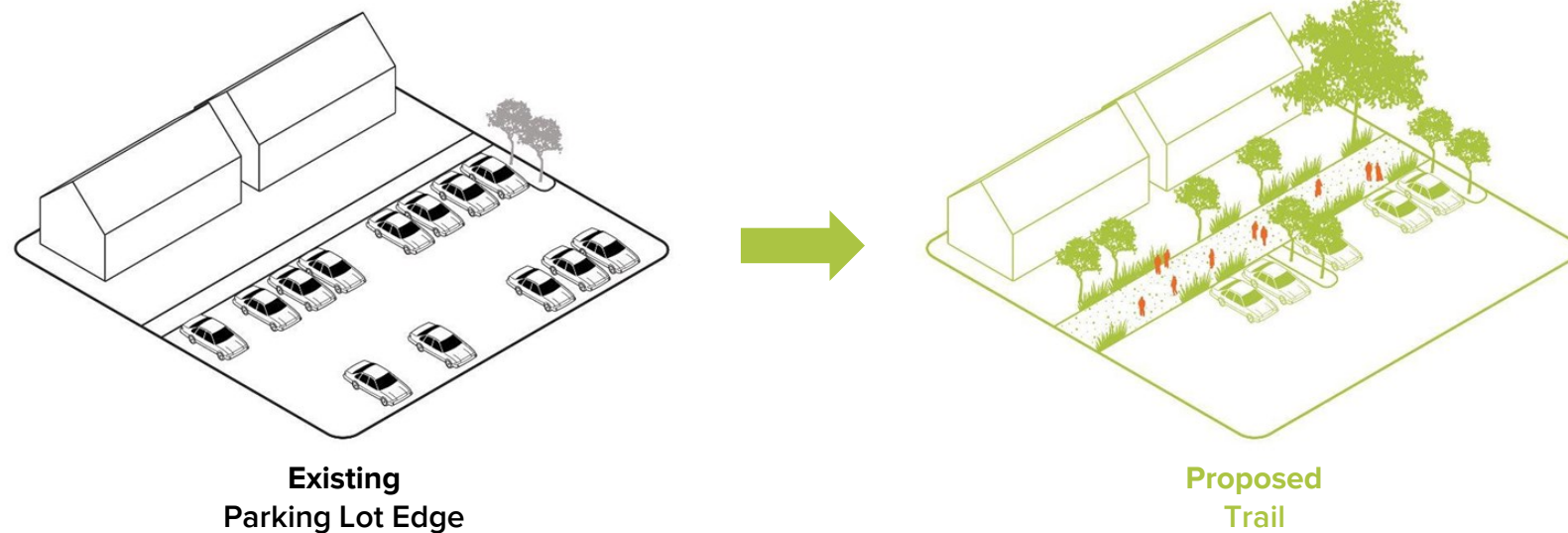

Existing
Parking Lot Edge

Proposed
Trail



Santa Maria Valley Multi-Purpose Trail
Santa Maria, CA

Source: TrailLink

OPEN SPACE TOOLKIT: POCKET PARK



Intent and Description

Pocket parks offer places for gathering or relaxation, typically in medium or higher density areas. They can offer a variety of uses, including community gardens, play spaces, socialization, etc.

Applicability

Typically less than an eighth of an acre and can be placed in vacant lots, abandoned alleyways, public land where roads intersect, or other underutilized space.

General Plan Land Use Designations

High Density Residential (HDR-70/35), Medium Density Residential (MDR-12), Low Medium Density Residential (MDR-10), Community Commercial (CC), Broadway Mixed Use (BMU-70/35), Main Street Mixed Use (MMU-70/35), Central District (CD), Commercial/Professional Office (CPO), Specific Plan (SP), Planned Annexation (PA)

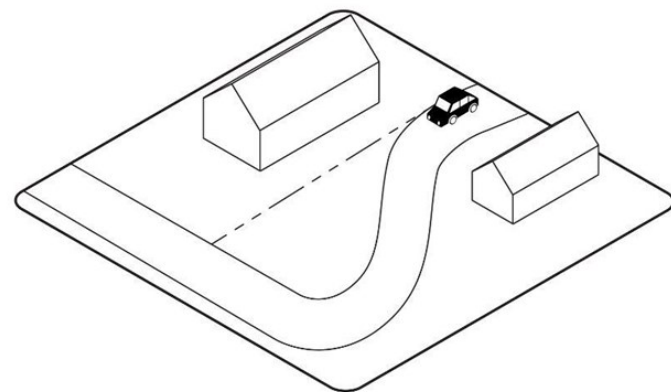

Existing Residual Space



Proposed Pocket Park



DeKalb, Ill

Source: Ayres Associates



Downtown Texarkana
Texarkana, TX

Source: Texarkana Central

OPEN SPACE TOOLKIT: FOOD TRUCK POD



Intent and Description

Food truck pods provide locations for entrepreneurs to sell their cuisine and offer places for community gathering. They can be located in temporary locations or more formalized settings.

Applicability

These areas can be placed in a variety of spaces, including underutilized parking lots, public parks, and/or adjacent to other community gathering locations.

General Plan Land Use Designations

Recreational Open Space (ROS), Community Facilities (CF), High Density Residential (HDR-35/22), Medium Density Residential (MDR-12), Community Commercial (CC), Broadway Mixed Use (BMU-70/35), Main Street Mixed Use (MMU-70/35), Central District (CD), Commercial/Professional Office (CPO), Neighborhood Commercial (NC), Light Industrial (LI), Specific Plan (SP), Planned Annexation (PA)

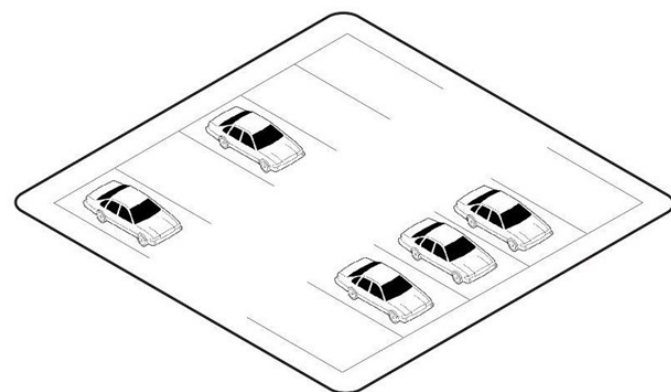

Existing
Surface Parking Lot

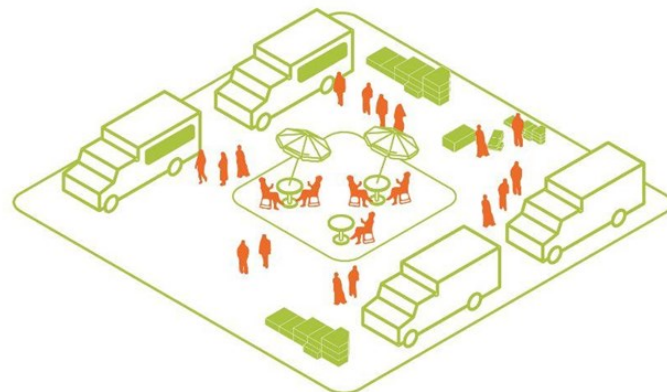

Proposed
Food Truck Pod



Food Truck Village
San Luis Obispo, CA

Source: Cal Poly Corp



East Village
Little Rock, AR

Source: About You Magazine

STREETS TOOLKIT: SIDEWALK WIDENING



Intent and Description

Widened sidewalks offer enhanced usage for many users. Business can use sidewalks to extend their businesses outside (e.g. tables for eating and drinking, outdoor display). Additional sidewalk width encourages pedestrians to navigate sidewalks in a social setting, allowing couples and small groups to walk side by side.

Applicability

Wide sidewalks should be prioritized in urban commercial and medium- to high-density residential areas.

General Plan Land Use Designations

Community Facilities (CF), High Density Residential (HDR-35/22), Medium Density Residential (MDR-12), Community Commercial (CC), Broadway Mixed Use (BMU-70/35), Main Street Mixed Use (MMU-70/35), Central District (CD), Neighborhood Commercial (NC), Specific Plan (SP)

Street Classification(s)

Primary Arterial, Secondary Arterial, Collector Road

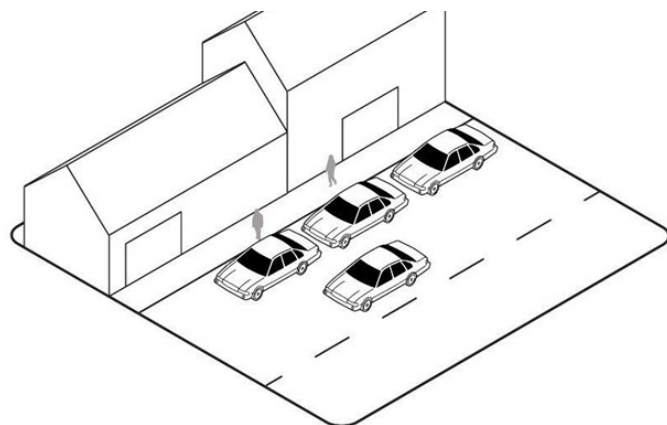

Existing
Typical Sidewalk

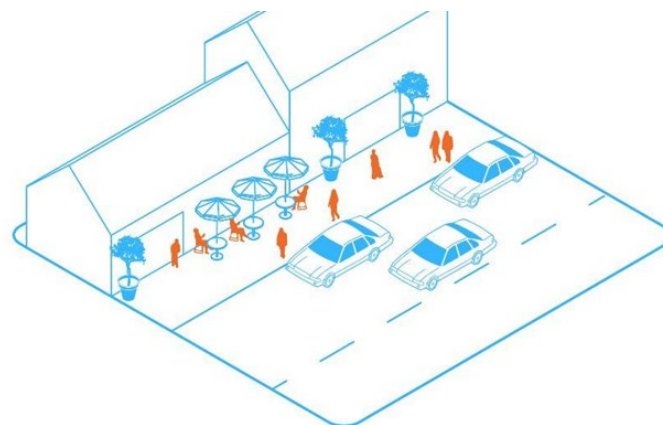

Proposed
Sidewalk Widening



Downtown SLO
San Luis Obispo, CA

Source: Hiking In Big Sur



Downtown Solvang
Solvang, CA

Source: California.com

STREETS TOOLKIT: STREET TREES



Intent and Description

Tree-lined streets offer myriad benefits such as offering a buffer for pedestrians from traffic, offering shade, reducing the urban heat island effect, increasing adjacent property values, improving stormwater drainage flows, improving air quality, and aesthetically enhancing urban environments.

Applicability

Street trees should be prioritized, especially in areas with considerable pedestrian demand or where demand is desirable.

General Plan Land Use Designations

Streets trees should be considered in all land use designations, but should be prioritized in Recreational Open Space (ROS), Community Facilities (CF), High Density Residential (HDR-35/30), Medium Density Residential (MDR-12), Community Commercial (CC), Broadway Mixed Use (BMU-70/35), Main Street Mixed Use (MMU-70/35), Neighborhood Commercial (NC), Planned Annexation (PA)

Street Classification(s)

All designations

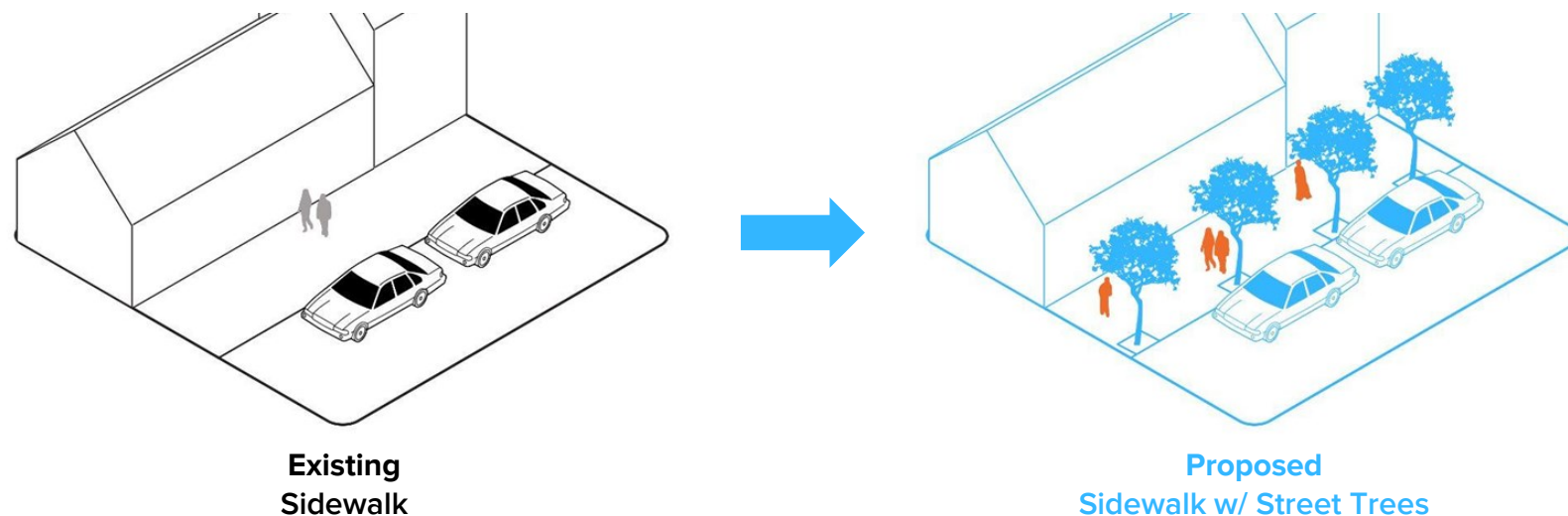

STREETS TOOLKIT: FURNISHINGS



Intent and Description

Furnishings offer amenities that make the public realm more inviting and comfortable for people. These can include places to sit, secure a bike, or throw out trash or recyclables. They can also include pedestrian-oriented and/or decorative lighting.

Applicability

Furnishings should be provided in walkable pedestrian-priority areas (e.g. commercial and mixed use districts as well as bus stops).

General Plan Land Use Designations

Recreational Open Space (ROS), Community Facilities (CF), High Density Residential (HDR-35/30), Medium Density Residential (MDR-12), Community Commercial (CC), Broadway Mixed Use (BMU-70/35), Main Street Mixed Use (MMU-70/35), Central District (CD), Commercial/Professional Office (CPO), Neighborhood Commercial (NC), Specific Plan (SP), Planned Annexation (PA)

Street Classification(s)

Primary Arterial, Secondary Arterial

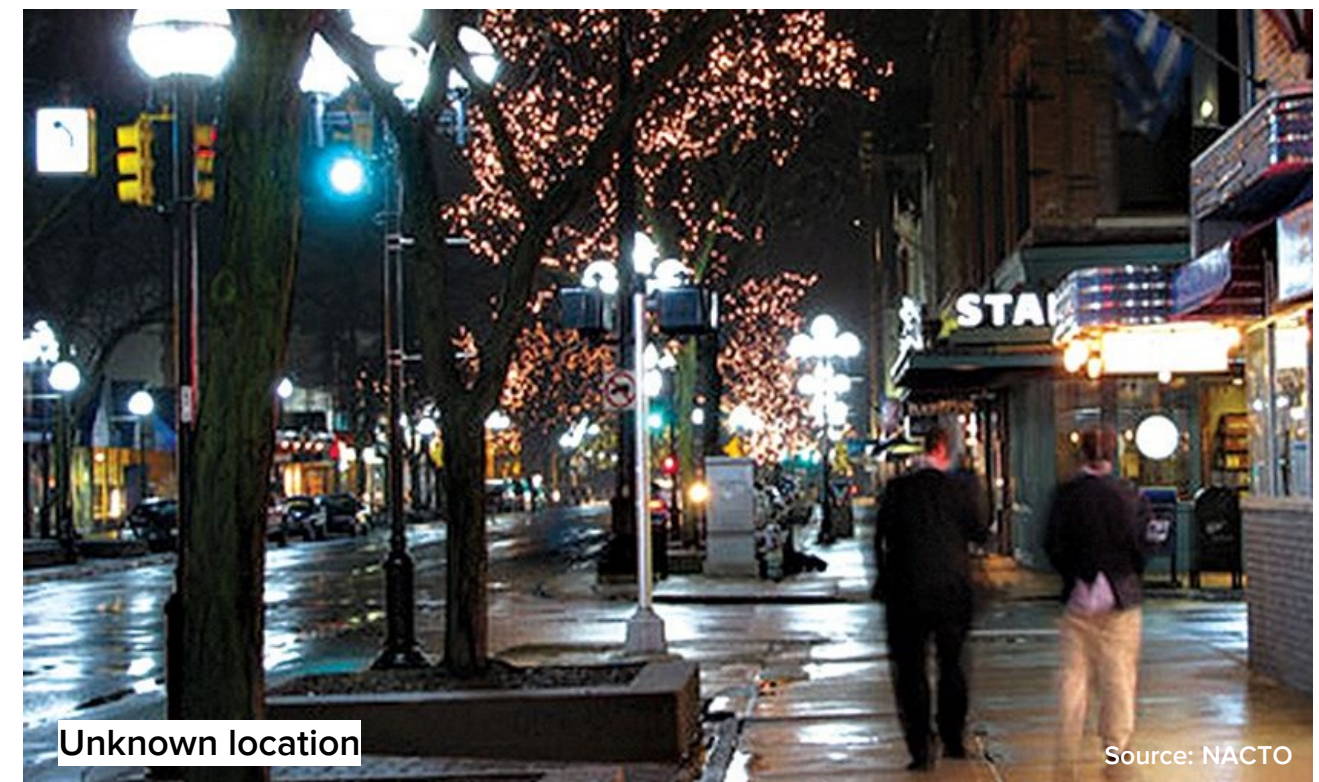
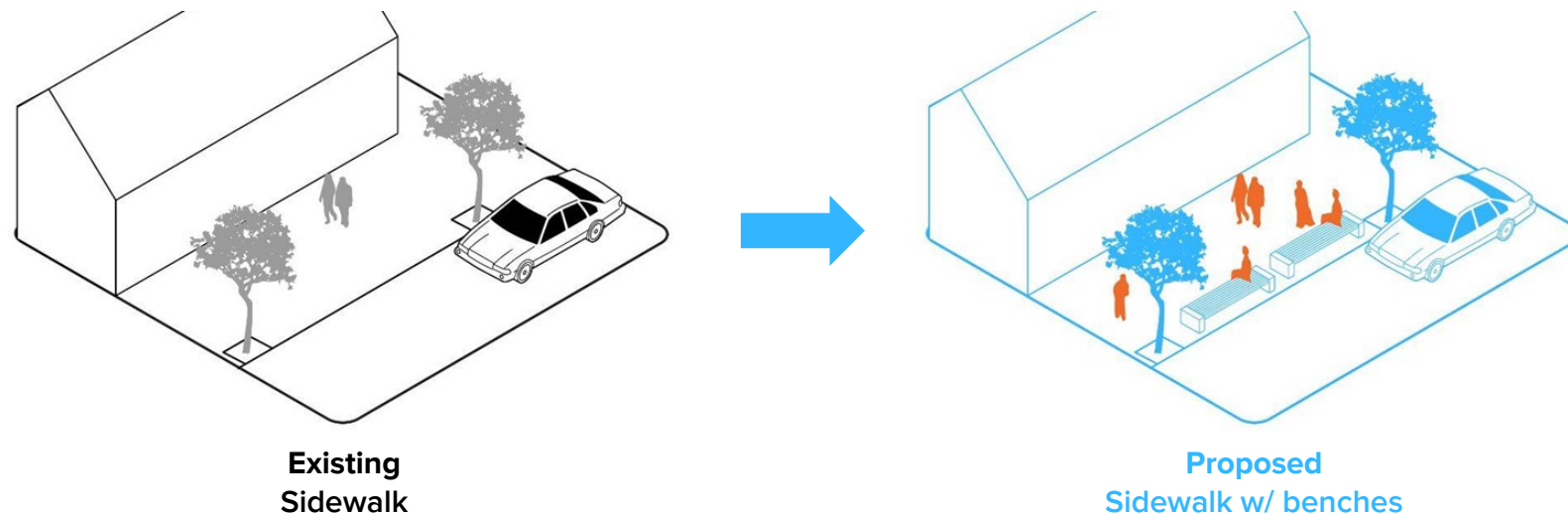

STREETS TOOLKIT: LANDSCAPE STRIP



Intent and Description

Offer barriers for pedestrians from automobiles, add pervious surface area for stormwater runoff, and often space for shade trees. They are located between the sidewalk and roadway.

Applicability

Landscape strips should be considered along reconstructed roadways where changes in land use anticipate higher densities of residents or street-fronting businesses.

General Plan Land Use Designations

Recreational Open Space (ROS), Community Facilities (CF), High Density Residential (HDR-35/30), Medium Density Residential (MDR-12), Community Commercial (CC), Broadway Mixed Use (BMU-70/35), Main Street Mixed Use (MMU-70/35), Central District (CD), Neighborhood Commercial (NC), Specific Plan (SP), Planned Annexation (PA)

Street Classification(s)

Primary Arterial, Secondary Arterial, Collector Road

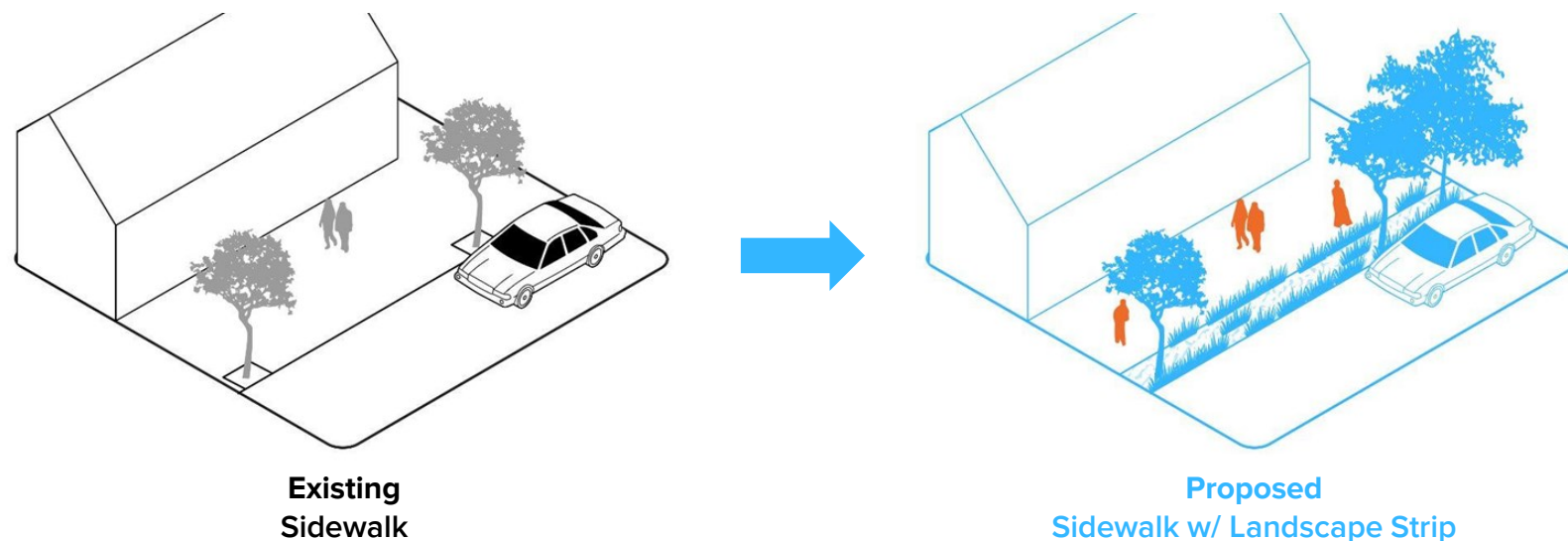

STREETS TOOLKIT: CURB EXTENSION / BULB OUT



Intent and Description

Enhance safety by promoting traffic-calming and by reducing crossing distances for pedestrians. Curb extensions enlarge the pedestrian realm at intersections and balance the roadway width.

Applicability

Curb extensions should be prioritized at higher pedestrian priority areas. A tactical and/or temporary materials approach for testing and phased implementation should be considered.

General Plan Land Use Designations

High Density Residential (HDR-35/30), Medium Density Residential (MDR-12), Community Commercial (CC), Broadway Mixed Use (BMU-70/35), Main Street Mixed Use (MMU-70/35), Central District (CD), Neighborhood Commercial (NC), Specific Plan (SP), Planned Annexation (PA)

Street Classification(s)

Primary Arterial, Secondary Arterial, Collector Road, Local Streets

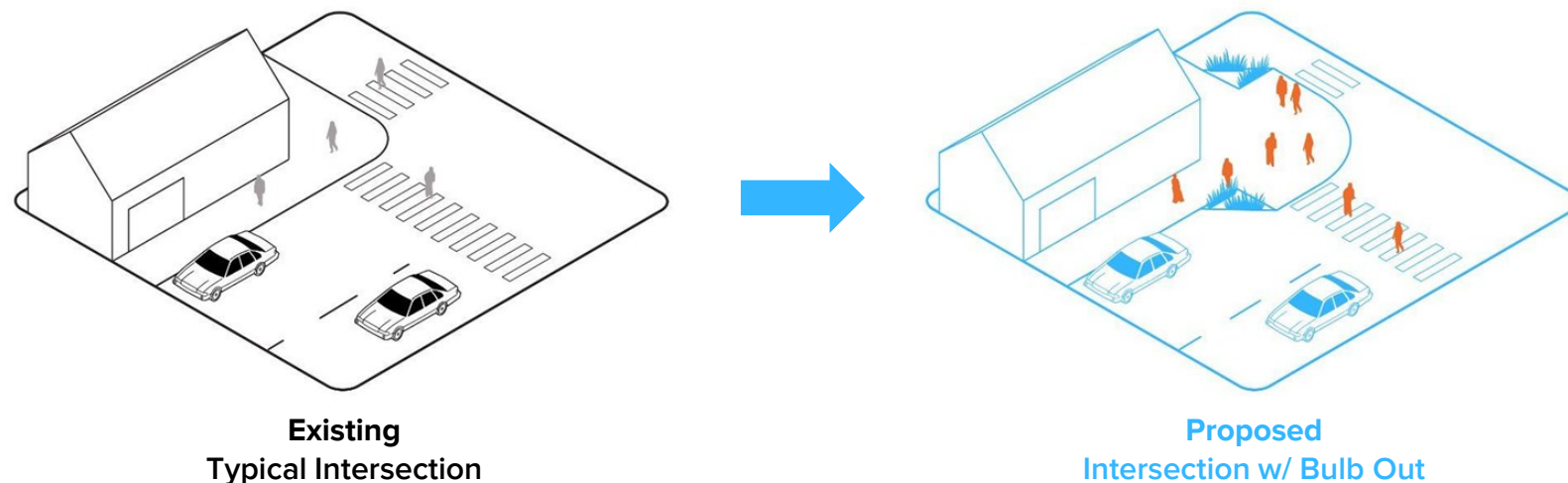

STREETS TOOLKIT: ALLEYWAY ACTIVATION



Intent and Description

Convert underutilized public rights-of-way into intentionally useful, safe, and fun places. Adjacent businesses and/or residents should be encouraged to engage and help activate these spaces with surfaces, lighting, and vegetation that make them inhabitable.

Applicability

Activation of alleyways should be considered in areas of redevelopment and reinvestment.

General Plan Land Use Designations

Community Commercial (CC), Broadway Mixed Use (BMU-70/35), Main Street Mixed Use (MMU-70/35), Central District (CD), Specific Plan (SP)



Downtown
Fort Collins, CO

Source: Downtown Fort Collins

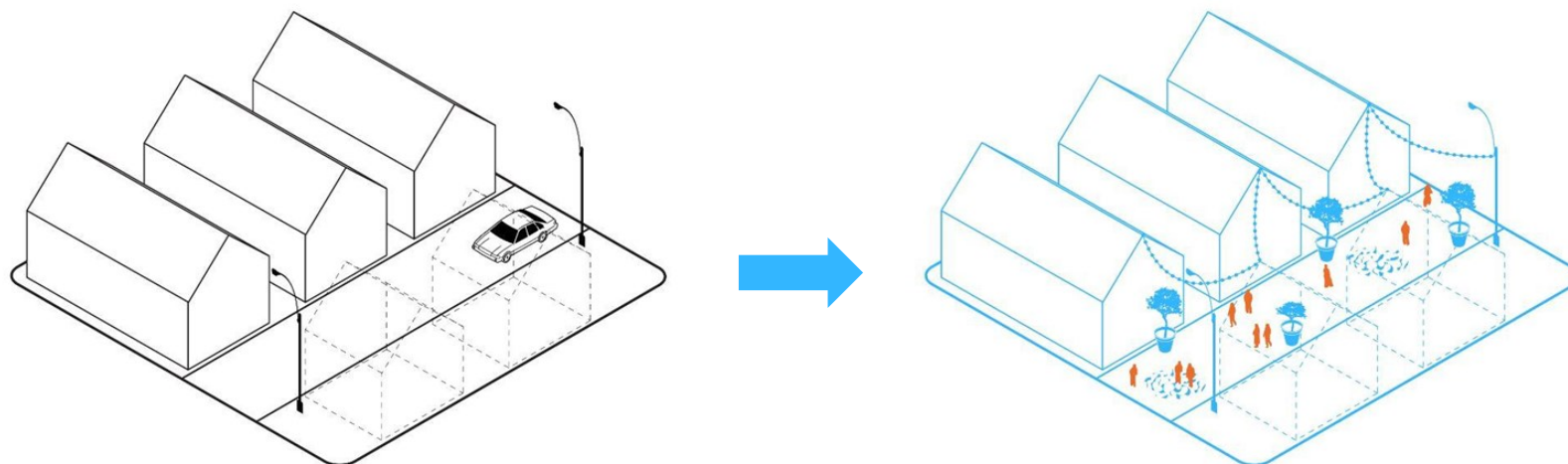

Existing
Alleyway

Proposed
Alleyway Activation



Bradley Plaza Green Alley
Pacoima, CA

Source: Arup

STREETS TOOLKIT: SLOW STREET



Intent and Description

Slow streets are primarily residential streets that promote walking, riding, play, and socializing opportunities. These streets limit through traffic and encourage local traffic to move slowly and carefully.

Applicability

Slow streets should be considered in residential neighborhoods and can be strategically located to augment the community's bikeway network.

General Plan Land Use Designations

High Density Residential (HDR-35/30), Medium Density Residential (MDR-12), Low Medium Density Residential (LMDR-8), Low Density Residential (LDR-5), Lower-Density Residential (LWDR-4)

Applicable Street Classification(s)

Local Streets, Minor Streets

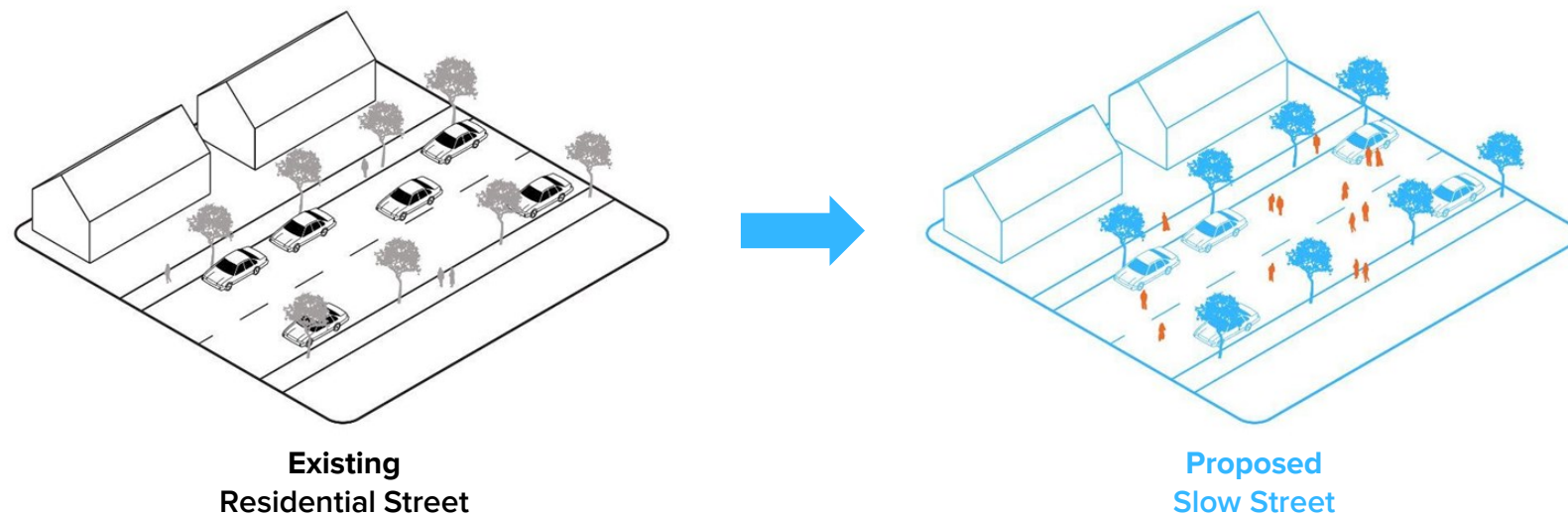

STREETS TOOLKIT: PARKLET



Intent and Description

Parklets offer semi-permanent sidewalk extensions that provide adjacent businesses additional space for customers, most often used for food and beverage. These elements provide activation of the public realm.

Applicability

Parklets perform best when located adjacent to a sponsoring commercial / retail business or other entity who will activate and manage it.

General Plan Land Use Designations

Community Commercial (CC), Broadway Mixed Use (BMU-70/35), Main Street Mixed Use (MMU-70/35), Neighborhood Commercial (NC), Specific Plan (SP), Planned Annexation (PA)

Street Classification(s)

Primary Arterial, Secondary Arterial, Collector Road

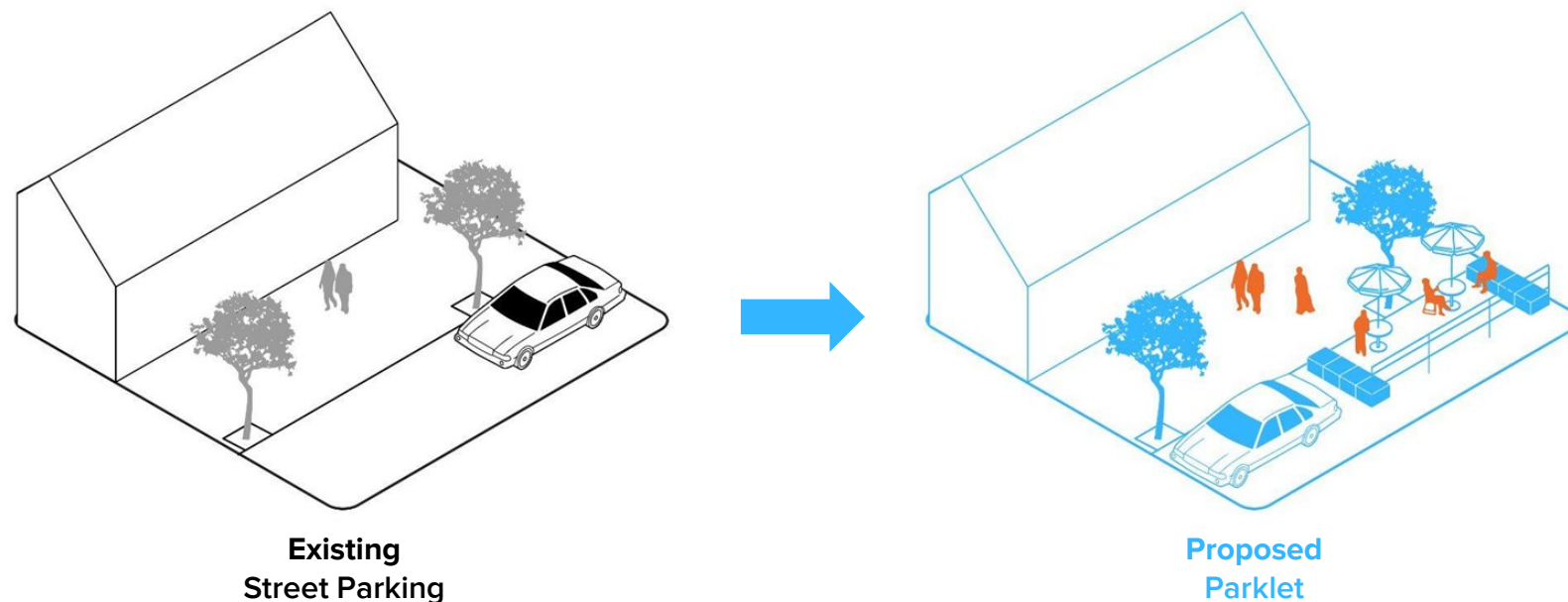

STREETS TOOLKIT: GATEWAY



Intent and Description

Gateways demarcate entrances to character areas such as commercial districts and neighborhoods. Such elements should embody the character of the area and can be expressed in a variety of ways.

Applicability

Gateways are best located along key community streets at the perimeter and/or center of character areas, such as downtown or a historic neighborhood.

General Plan Land Use Designations

Community Commercial (CC), Broadway Mixed Use (BMU-70/35), Main Street Mixed Use (MMU-70/35), Central District (CD), Specific Plan (SP), Planned Annexation (PA)

Street Classification(s)

Primary Arterial, Secondary Arterial

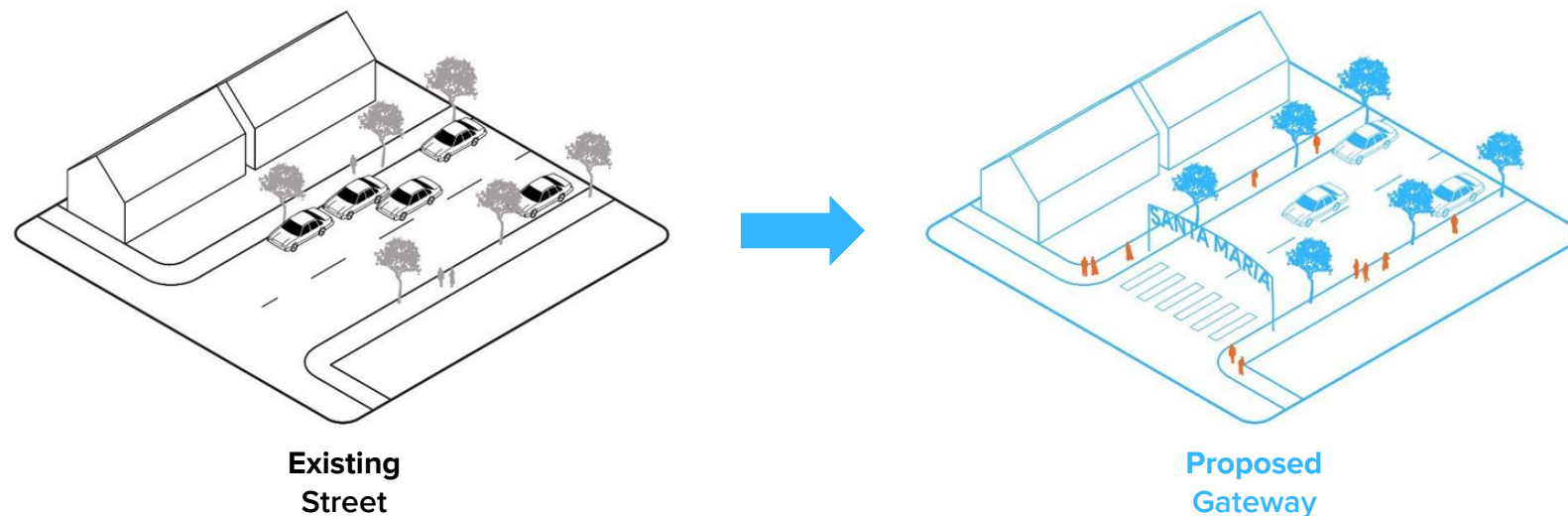

STREETS TOOLKIT: PUBLIC ART



Intent and Description

Public art elicits feelings through a variety of art forms. Murals, sculpture, statues, and interactive installations are just a few examples.

Applicability

A high priority should be placed on including public art elements in desired redevelopment areas and new development.

General Plan Land Use Designations

Recreational Open Space (ROS), Community Facilities (CF), High Density Residential (HDR-35/30), Medium Density Residential (MDR-12), Community Commercial (CC), Broadway Mixed Use (BMU-70/35), Main Street Mixed Use (MMU-70/35), Central District (CD), Commercial/Professional Office (CPO), Neighborhood Commercial (NC), Specific Plan (SP), Planned Annexation (PA)

Street Classification(s)

Primary Arterial, Secondary Arterial, Collector Road

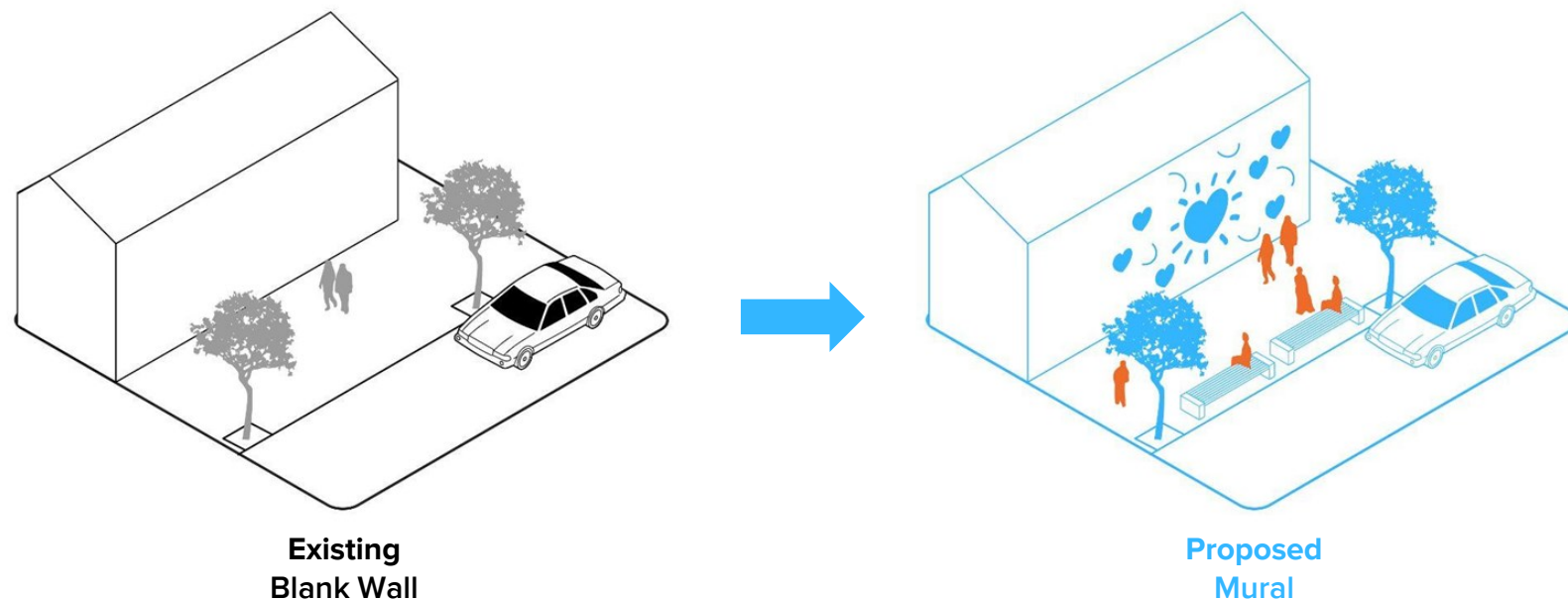

STREET SECTIONS: PRIMARY ARTERIAL

These sections highlight standard widths within the right-of-way for a primary arterial. In the image to the upper right, an optional protected bike lane is illustrated along wide sidewalks that contain a landscape strip, street trees, furnishings, and pedestrian-scale lighting.

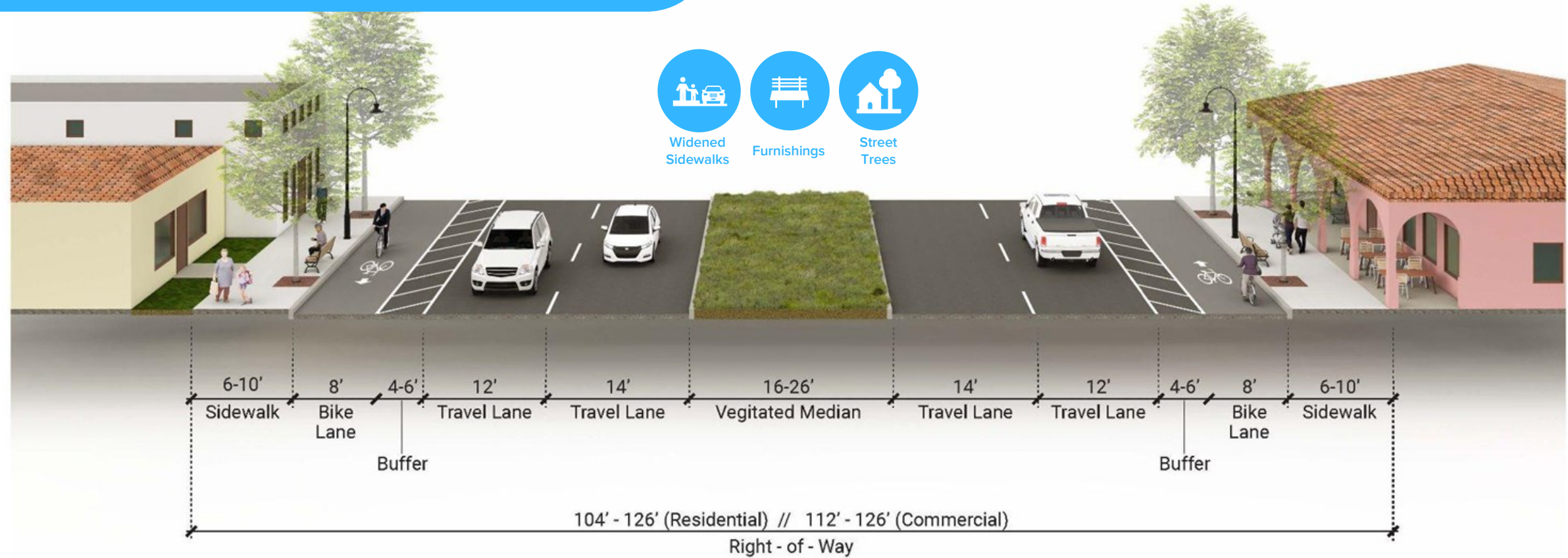

In the lower-right image, a bus lane has been illustrated in lieu of a buffered bike lane where transit is prioritized.

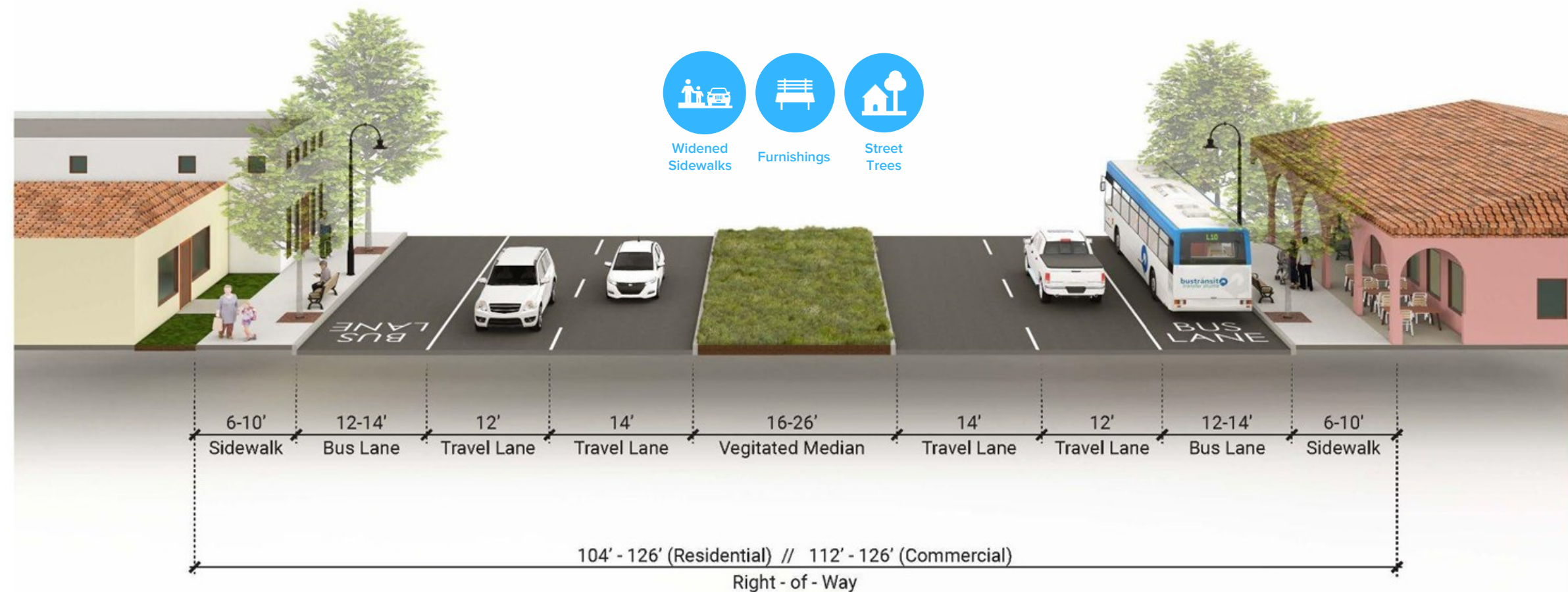

STREET SECTIONS: SECONDARY ARTERIAL

These sections highlight standard widths within the right-of-way for a secondary arterial. In the image to the upper right, an optional protected bike lane is illustrated along wide sidewalks that include landscape strips, street trees, furnishings, and pedestrian-scale lighting.

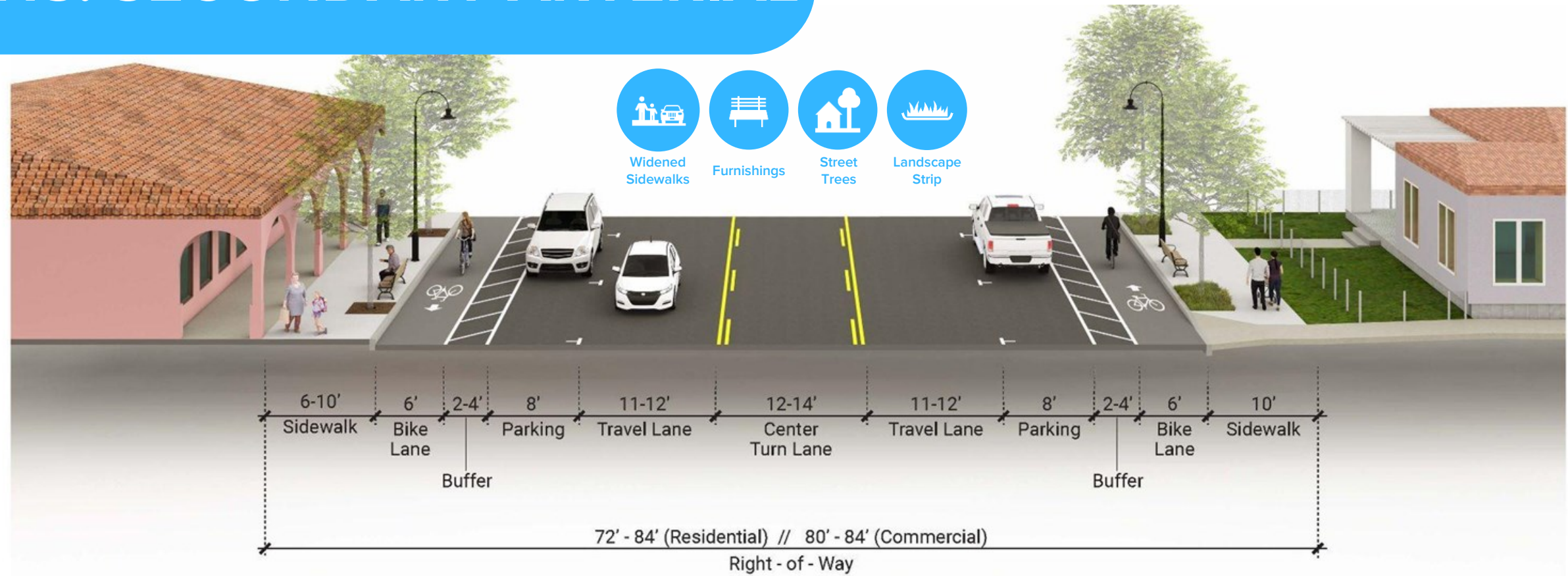

Whereas, in the lower-right image, on-street parking is located along the curb to allow flexible uses to take place, such as parklets. A narrower, buffered bike lane can still exist.

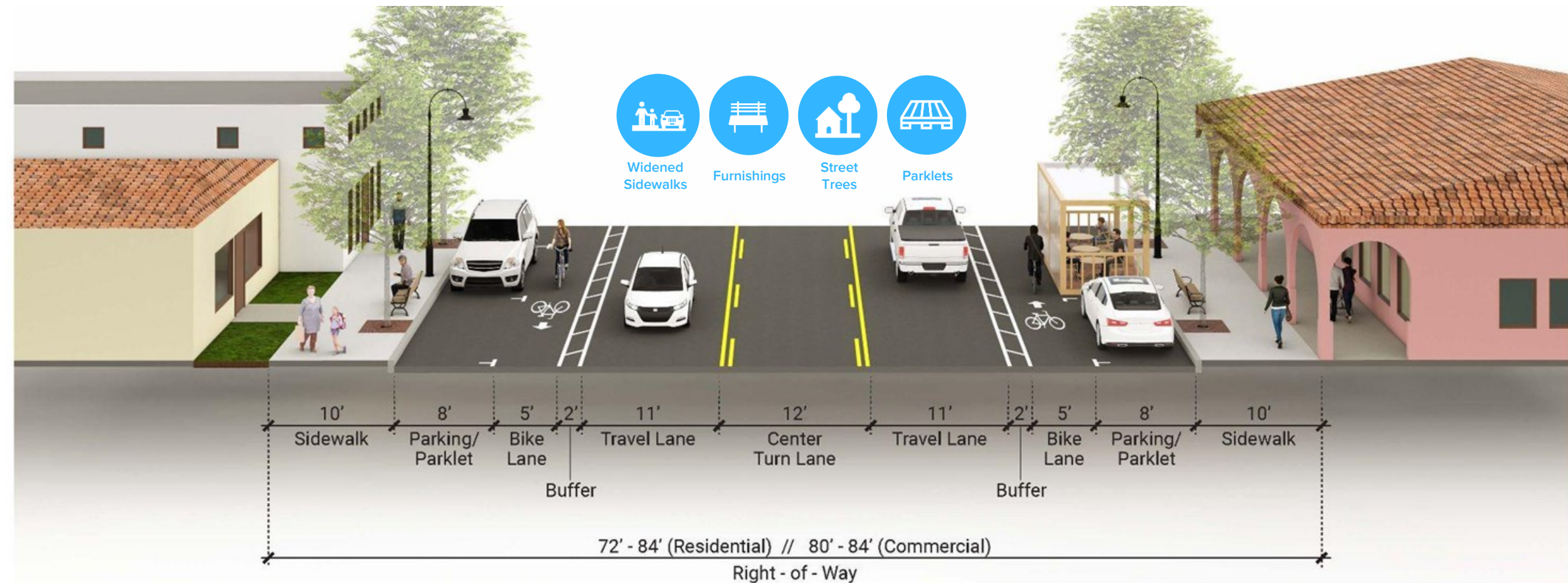

TOOLKIT APPLICABLE LAND USE DESIGNATIONS

OPEN SPACES

	Primary Agricultural Open Space (AOS-I)	Secondary Agricultural Open Space (AOS-II)	Conservation Open Space (COS)	Recreation Open Space (ROS)	Community Facilities (CF)	High Density Residential (HDR-35/30)	Medium Density Residential (MDR-12)	Low Medium Density Residential (LMDR-8)	Low Density Residential (LDR-5)	Lower-Density Residential (LWDR-4)	Community Commercial (CC)	Broadway Mixed Use (BMU-70/35)	Main Street Mixed Use (MMU-70/35)	Central District (CD)	Specific Plan (SP)	Commercial/Professional Office (CPO)	Neighborhood Commercial (NC)	General Industrial (GI)	Freeway Service (FS)	Heavy Commercial/Manufacturing (HCM)	Light Industrial (LI)	Airport - Airport Services (A-AS)	Planned Annexation (PA)
Natural Open Space			X																				X
Park	X	X	X	X	X	X	X	X	X	X	X	X	X	X	X			X			X		X
Plaza					X	X	X	X				X	X	X	X								X
Trail	X	X	X	X	X	X	X	X	X	X	X		X	X	X	X	X	X	X	X	X	X	X
Pocket Park						X	X				X	X	X	X	X	X							
Food Truck Pod				X		X	X				X	X	X	X	X	X	X				X		

STREETS

Sidewalk Widening					X	X	X					X	X	X	X		X						
Street Trees				X	X	X	X	X	X	X	X	X	X	X	X	X	X						X
Furnishings				X		X	X				X	X	X	X	X	X	X						
Landscape Strip						X	X				X	X	X	X	X		X						X
Curb Extension						X	X				X	X	X	X	X		X						X
Alleyway Activation											X	X	X	X	X								
Slow Street						X	X	X	X	X													
Parklets											X	X	X	X	X		X						
Gateways											X	X	X	X	X								X
Public Art						X	X				X	X	X	X	X	X	X						X

ALTERNATIVE: ANNEXATION

This map shows key areas of change in Alternative A: Annexation that distinguish this Alternative from the other two Alternatives. The toolkit items shown on this slide apply to the Proposed Annexation (PA) land use, and illustrate potential open space and street concepts that can be implemented in the purple areas shown with this Alternative.

Natural Open Space



Parks



Plazas



Trails



Street Trees



Landscape Strip



Curb Extensions



Gateways



Public Art

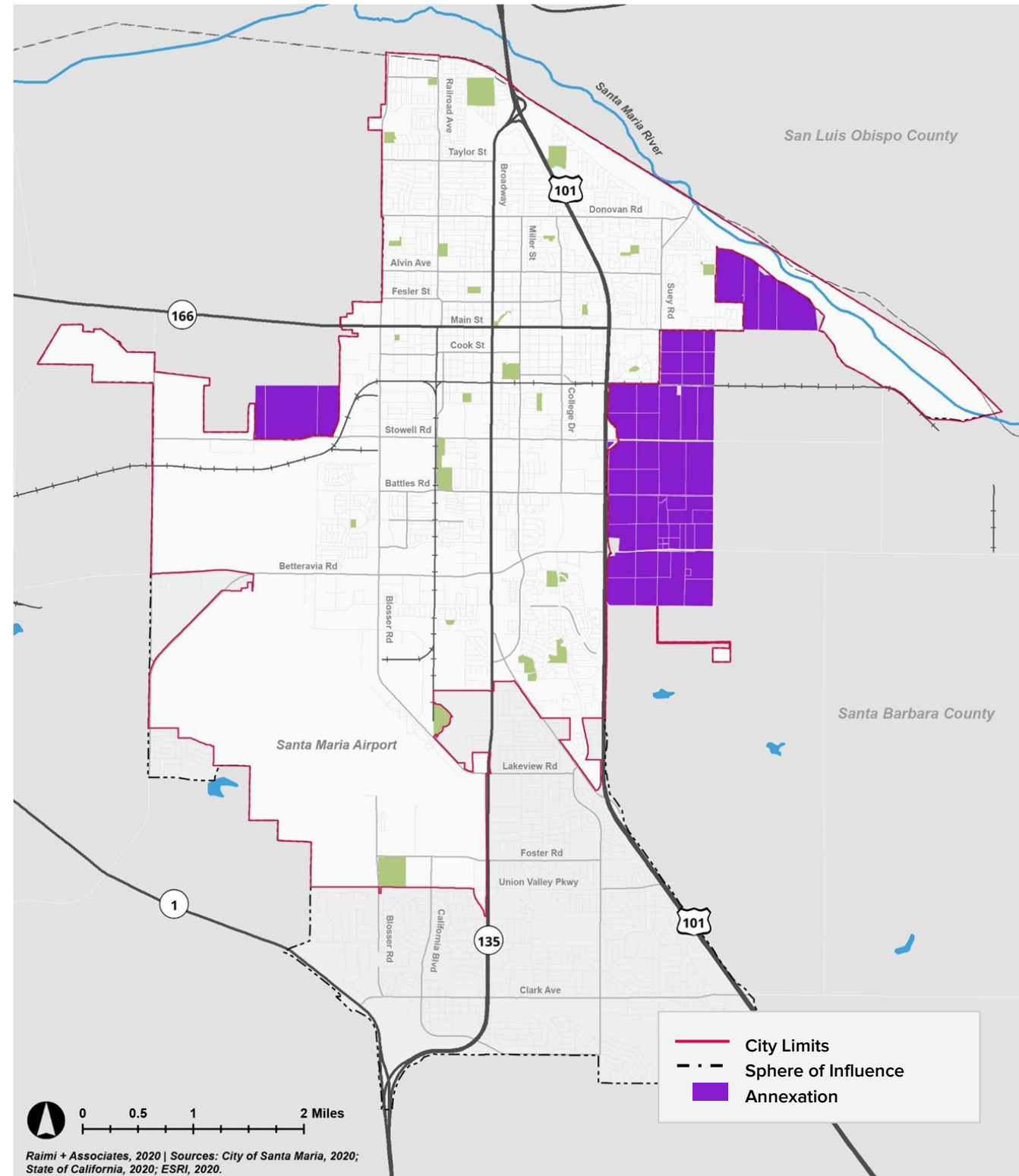

Raimi + Associates, 2020 | Sources: City of Santa Maria, 2020; State of California, 2020; ESRI, 2020.

ALTERNATIVE: CITY INFILL

This map shows key areas of change in Alternative B: City Infill that distinguish this Alternative from the other two Alternatives. The toolkit items shown on this slide apply to the Broadway Mixed Use (BMU-70/35), Main Street Mixed Use (MMU-70/35), Central District (CD-II), and Specific Plan (SP) land uses and illustrate potential open space and street concepts that can be implemented in the purple areas shown with this Alternative.

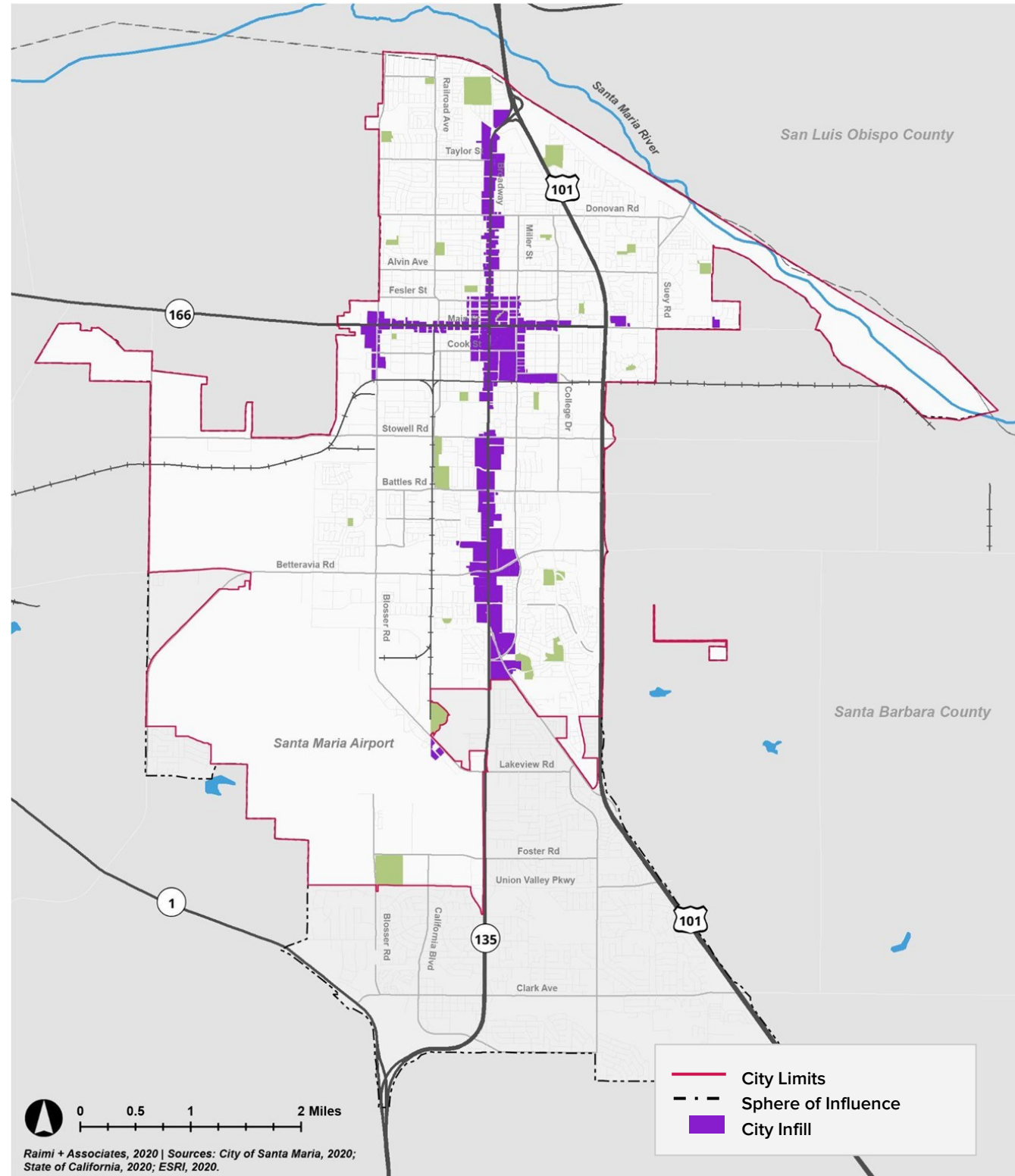

ALTERNATIVE: HYBRID

This map shows key areas of change in Alternative C: Hybrid that distinguish this alternative from the other two alternatives. The toolkit items shown on this slide apply to the Proposed Annexation (PA), Broadway Mixed Use (BMU-70/35), Main Street Mixed Use (MMU-70/35), Central District (CD), and Specific Plan (SP) land uses, and illustrate potential open space and street concepts that can be implemented in the purple areas shown with this Alternative.

Natural Open Space



Parks



Food Truck Pods



Trails



Pocket Parks



Plazas

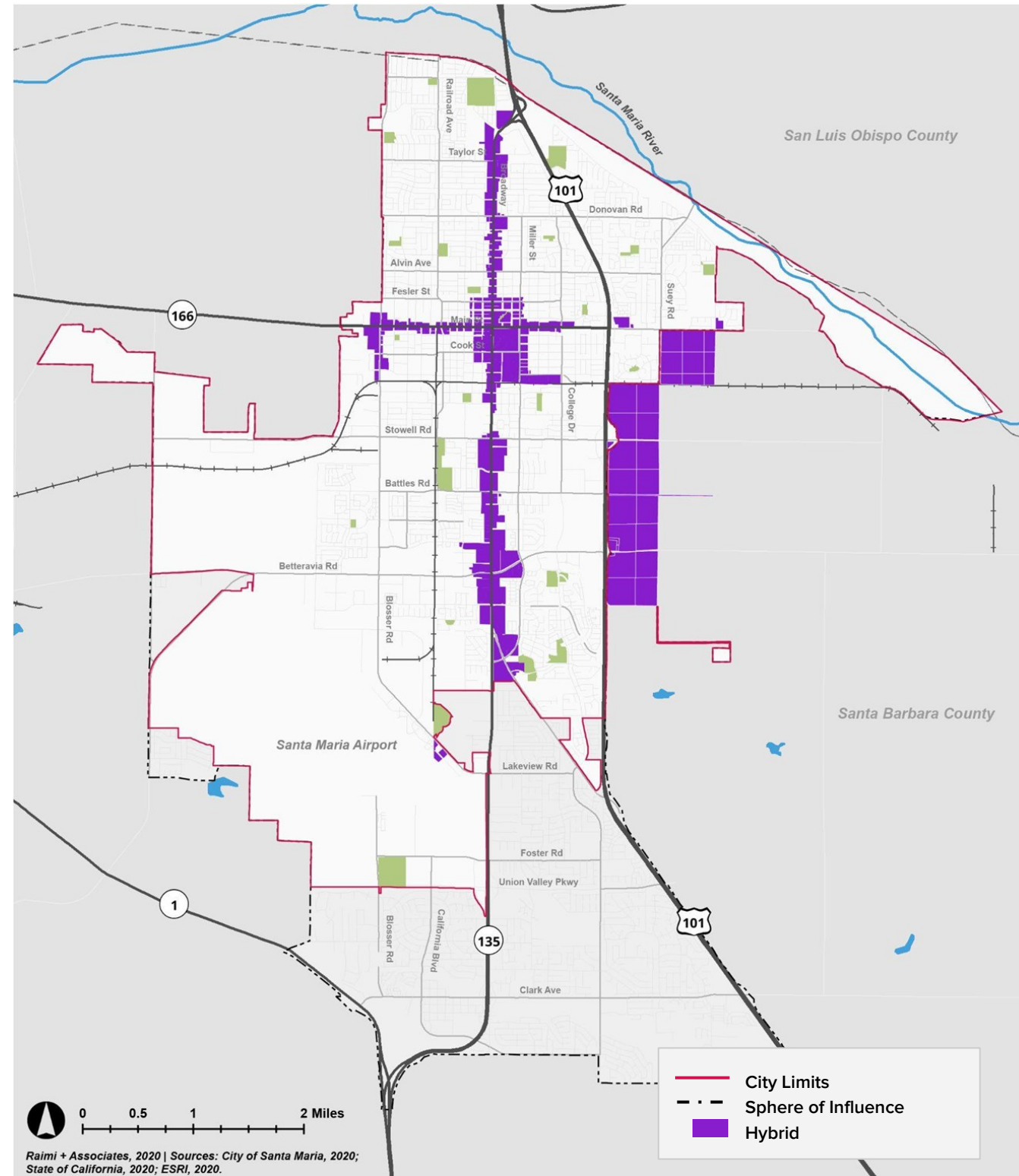

Slow Streets



Alleyway Activation



Sidewalk Widening



Landscape Strips



Curb Extensions



Parklets



Street Trees



Furnishings



Gateways



Public Art